

# Austrian Space Applications Programme

> **asap** >

Projects - 7<sup>th</sup> and 8<sup>th</sup> Call for Proposals

2012

Photo: Galileo satellites, Picture Credit: ESA

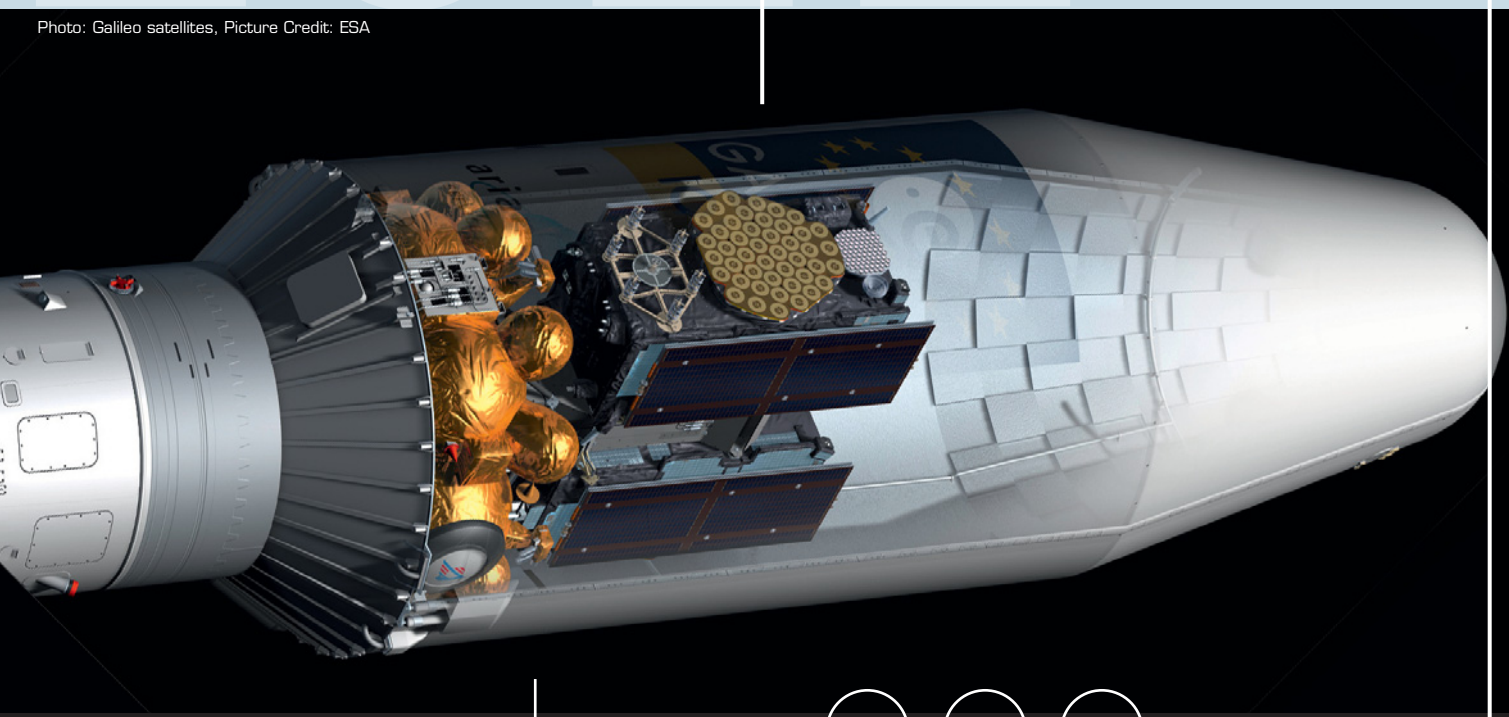

> EDITION 1 > 2012 >



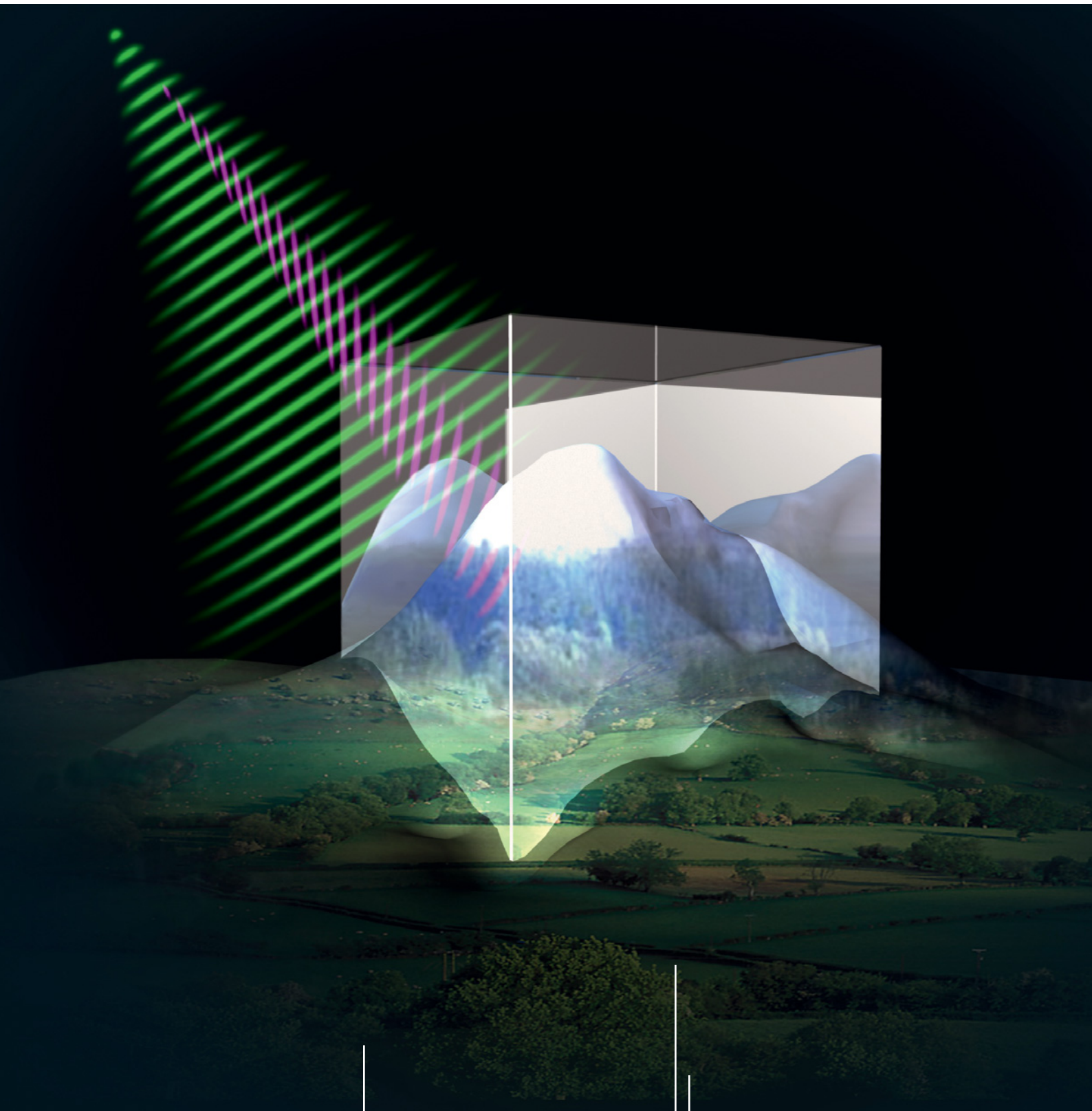

# Foreword



Credit: Rigaud

Many innovations we use in our everyday lives are based on space research – from navigation systems to weather forecasting. Austrian scientists make a major contribution to the development of important space technology. The first two Austrian satellites are soon to be sent into orbit. These mini satellites “made in Austria” will provide us with important data on the origin of the universe.

The satellite project illustrates the important role of space exploration-related activities in Austrian research. I aim to ensure that Austria’s position in the space sector is further strengthened through targeted funding measures. Consistent participation in European Space Agency (ESA) programmes as well of course as our own national space programme ASAP have secured Austria’s role as an international player in the field of space research. Currently, around 100 Austrian companies are key providers of cutting-edge technology on the international market. With an annual turnover of 5.4 billion euros and around 32,000 employees, the European space industry is an important market for Austrian technology.

Space research is therefore also an important driving force for Austria’s economy. In Austria, some 1,000 scientists, researchers and engineers are involved in developing technical standards for satellites, launch vehicles, ground stations or software programmes. Increasingly precise observations of our planet enable earlier detection of impending natural disasters such as flooding.

This brochure provides an overview of the projects currently being undertaken as part of the Austrian Space Applications Programme ASAP. It serves not only to demonstrate the high economic relevance of the space research traditionally carried out here in Austria but also highlights Austria’s technological excellence in this field.

A handwritten signature in blue ink that reads "Doris Bures". The signature is fluid and cursive, written in a professional style.

**Doris Bures**  
Federal Minister for Transport,  
Innovation and Technology

# Content

<b>Programme Description</b> .....	<b>5</b>	DIACERAM .....	45
<b>Earth Observation</b> .....	<b>6</b>	FRESSCO .....	46
ACAP .....	7	FRPBonding .....	47
AIM4X .....	8	ISS-SLEEP-KIT .....	48
AQA-PM .....	9	NEMO .....	49
compact-PTR-TOF-MS .....	10	<b>Telecommunications</b> .....	<b>50</b>
CoReH2O-Science .....	11	ASLE .....	51
E04Water .....	12	CDPP .....	52
FarmSupport .....	13	COSA .....	53
GMSM II .....	14	GeMIE .....	54
HighSens .....	15	NextNav .....	55
LandSpotting .....	16	ONE-SAT-ILS .....	56
LISA .....	17	QTS .....	57
PRESENT .....	18	SGIS .....	58
RAPIDEM .....	19	TCTM .....	59
<b>Navigation</b> .....	<b>20</b>	TM/TC Modem .....	60
CrashPos .....	21	<b>Contacts</b> .....	<b>61</b>
FLIXDATE .....	22		
GIOMO .....	23		
I-Game NG .....	24		
LOPT-GNSS .....	25		
NAVVAT 2 .....	26		
PPP-Serve .....	27		
PURSIT .....	28		
RT-PPP .....	29		
SoftGNSStrusted .....	30		
<b>Space Science</b> .....	<b>31</b>		
3D-POC .....	32		
BRITE-Austria .....	33		
CDSM TRL-Uplift .....	34		
JUNO/Waves .....	35		
MDS-MARS 500 .....	36		
METTRANS-ISS FP .....	37		
MMS-DFG 2 .....	38		
TMIS.ascrea .....	39		
<b>Space Technology</b> .....	<b>40</b>		
ACTRESS .....	41		
ADAM .....	42		
ASOT .....	43		
BII-NACO .....	44		

# Austrian Space Applications Programme



## Programme Description

The Austrian Space Applications Programme ASAP was initiated by the Federal Ministry for Transport, Innovation and Technology (bmvit) in 2002. It is a bottom-up research funding programme targeted at space science, technology and applications. The programme is designed to enhance bilateral cooperation, support scientific participation in ESA and bilateral projects and complement development in the application domain. It also aims at promoting interesting technology niches in Austria. The Austrian Space Programme addresses Austrian and international scientists, scientific institutions, industrial enterprises and other companies, including SMEs located in Austria.

ASAP supports Austrian research institutions as well as commercial enterprises in their efforts to conduct space science and exploration projects, and to develop space technologies, products and services.

The programme elements "Scientific Excellence", "Economic Benefits" and "Benefits for Society" are determined by the main objectives of the Austrian Space Applications Programme:

- > Development of scientific instruments for European and international space missions
- > Building new scientific skills within the scope of space missions
- > Development of innovative technologies, products and processes
- > Diffusion of space technologies in other sectors
- > Utilization of space technology for further applications like navigation, telecommunication, Earth observation and integrated applications
- > Making use of the potential of space based applications in order to contribute solutions to the great challenges of our future

Furthermore the Austrian Space Applications Programme ASAP aims at building national and international networks through multi- and bilateral projects and at expanding user communities of space technology.

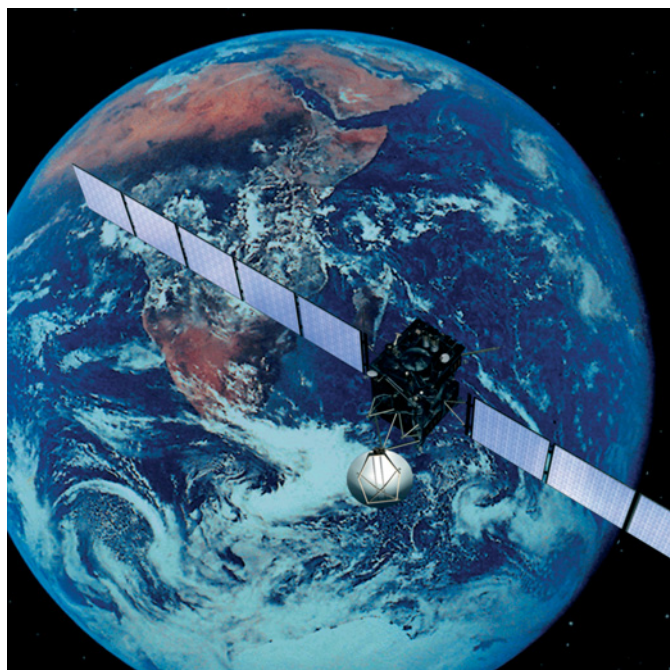

# Earth Observation

**ACAP**

**AIM4X**

**AQA-PM**

**compact-PTR-TOF-MS**

**CoReH<sub>2</sub>O-Science**

**EO4Water**

**FarmSupport**

**GMSM II**

**HighSens**

**LandSpotting**

**LISA**

**PRESENT**

**RAPIDEM**

# ACAP

## Global Gravity Field Modelling From Orbit Data Based on the Acceleration Approach

The main purpose of the ACAP project was to compute a global gravity field based on precise orbit information using the so-called acceleration approach. This method is based on Newton's second law of gravitation, which states that the acceleration of a mass is related to the forces acting on it. Transferred to a satellite this means that all forces acting on it cause accelerations. These accelerations cannot be observed directly, but they can be calculated from orbit positions by means of numerical differentiation. Beside some minor forces, like air drag, solar radiation pressure or gravity fields of the Moon, the Sun and other planets, the main force in this context is the Earth's gravity field.

Different simulations were carried out to test the method and find the best configuration for estimating the gravity field. Additionally different widely used numerical differentiators were tested to find the most appropriate method to derive the necessary accelerations. We tested Newton-Gregory interpolation, Taylor-MacLaurin differentiation and polynomial approximation. The investigations revealed that Newton-Gregory and Taylor-MacLaurin are only a special case of a polynomial approximation. Furthermore, using a polynomial provides far more flexibility in terms of degree, used epochs and degree of freedom. Based on these findings real data from ESA's GOCE (Gravity field and steady-state Ocean Circulation Explorer) mission was used to produce the gravity field solution shown in the illustration below.

The investigations showed that the acceleration approach is capable of producing competitive gravity field solutions, compared to current high-end models based on satellite and/or terrestrial data, especially in low degrees.

### Infobox

#### Project duration:

01 April 2011 – 31 July 2012

#### Coordinator:

Graz University of Technology

Institute of Theoretical Geodesy and Satellite Geodesy

Torsten Mayer-Gürr

Steyrergasse 30, 8010 Graz, Austria

T: +43 (0)316 873 – 6359

mayer-guerr@tugraz.at

www.itsg.tugraz.at

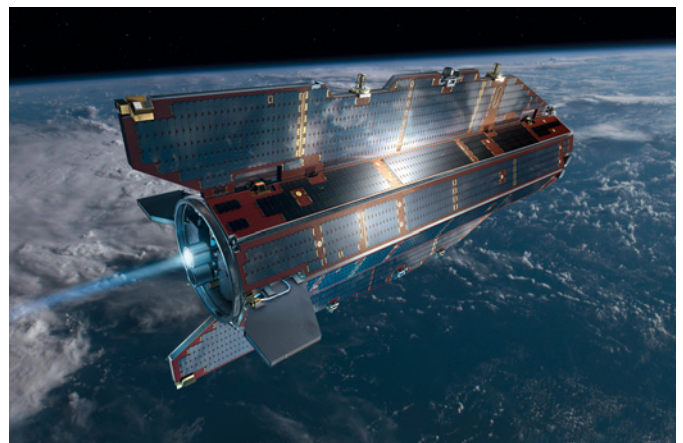

The GOCE satellite in orbit.

© ESA – AOES Medialab

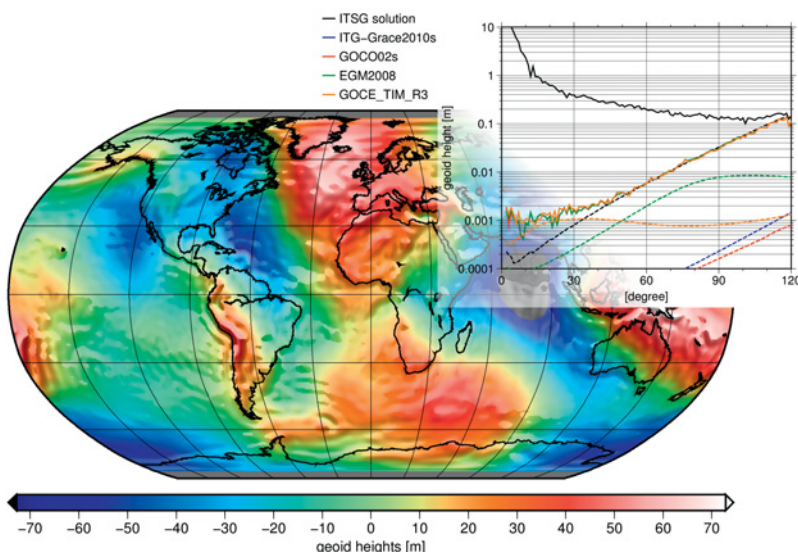

Gravity field from 16 months of GOCE orbit data displayed as geoid heights and the corresponding degree variances compared to state-of-the-art models.  
© ITSG

# AIM4X

## Advanced INSAR Methods for TanDEM-X

The AIM4X project exploits the innovative capabilities of recent high-resolution SAR and radar altimeter missions. The German TanDEM-X and the Italian COSMO-SkyMed missions are for the first time providing very high resolution SAR image data acquired in an optimized configuration for generating elevation information using SAR interferometry. Additionally, the Synthetic Aperture Interferometric Radar Altimeter (SIRAL) operating on board the ESA Earth Explorer mission Cryosat-2 provides profiles of precise vertical measurements of the Earth's surface enabling an intercomparison and validation of surface elevation from different sources. The focus of the project was put on SAR-based applications devoted to mapping and change detection in urban, forest and glacier regions. The project objectives included:

- > Investigation of the interferometric mapping potential of high-resolution TanDEM-X and COSMO-SkyMed data for different environmental characteristics, like urban areas, forests or glacier regions
- > Synergistic use of alternative processing methods, like stereo-radargrammetry and interferometry, and complementary image information in the mapping context, like backscatter, coherence and phase information
- > Retrieval methods of multi-temporal 2D and 3D information in urban, rural as well as glaciated environments
- > Innovative change detection procedures based upon integrated use of 2D/3D approaches as well as their application and validation under various environmental conditions
- > Generation and validation of surface elevation and deformation products from TanDEM-X, TerraSAR-X and COSMO-SkyMed SAR data for glaciers
- > Development and testing of synergistic tools for CryoSat-2 radar altimeter data and TanDEM-X SAR data for deriving volume changes and mass balance of glaciers

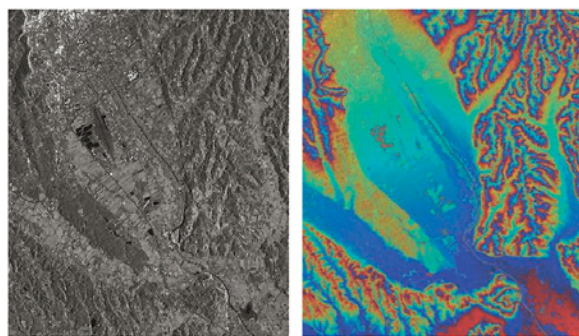

TanDEM-X amplitude image (left), colour-coded interferogram (centre) and digital surface model (DSM) generated therefrom (right). © JOANNEUM RESEARCH; input data provided by DLR

### Infobox

#### Project duration:

01 January 2011 – 30 June 2013

#### Coordinator:

JOANNEUM RESEARCH Forschungsgesellschaft mbH  
DIGITAL - Institute for Information and Communication  
Technologies (JR-DIG)

Hannes Raggam

Steyrergasse 17, 8010 Graz, Austria

T: +43 (0)316 876 – 1735

DIGITAL-FER@joanneum.at

www.joanneum.at

#### Partner:

ENVEO Environmental Earth Observation IT GmbH

Thomas Nagler

www.enveo.at

The applicability and benefit of the change detection developments for GMES services was demonstrated for selected test cases, comprising change detection and mapping in urban, forest and glacier environments. Related scenarios were specified in accordance with related GMES projects, like G-MOSAIC, GEOLAND or REDD/REDDAF, and the WCRP Climate and Cryosphere (CliC) Project.

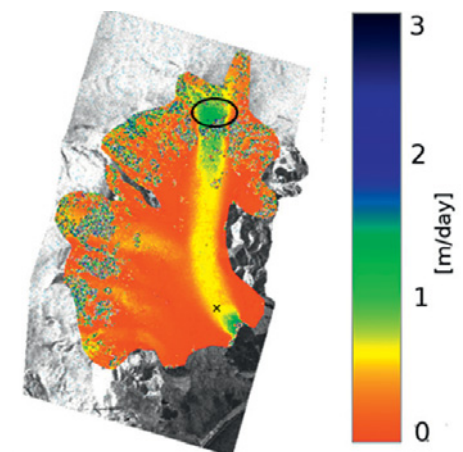

Surface displacement of Breiðamerkurjökull, Iceland, from COSMO-SkyMed data, acquired on 22 and 30 November 2010, overlaid on amplitude image. © ENVEO



# AQA-PM

## Extension of the Air-Quality Model for Austria With Satellite Based Particulate Matter Estimates

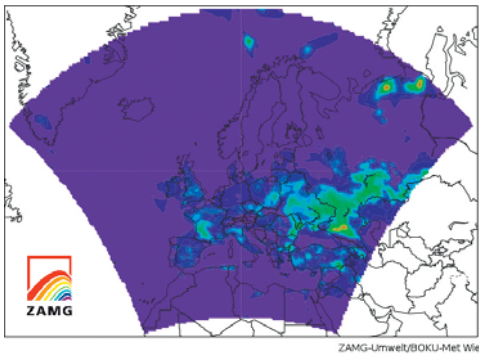

PM10 ground level  
distribution on a  
European domain.  
© ZAMG

Air quality is a key element for the well-being and quality of life of European citizens. It is regulated by EU legislation, which requires monitoring and assessment of air pollution, informing the public on air quality, predicting potential exceedance of specified quality levels, implementation of short-term action plans, and air quality management to attain specific limit and target values. The Air-Quality model for Austria (AQA) has been operated by ZAMG (Central Institute for Meteorology and Geodynamics) in cooperation with BOKU (University of Natural Resources and Life Sciences) by order of the regional governments since 2005. AQA issues daily forecasts of gaseous and particulate (PM10) air pollutants over Austria.

Significant progress has been made towards the increased use of satellite products related to air quality over the past few years. This progress has become possible due to advances in sensor technology and new algorithmic approaches. The goal of this project was to improve the PM10 forecasts for Austria by integrating satellite based measurements and to provide a comprehensive product platform.

The initial state of the atmosphere is not only essential for meteorological forecasts but also for models that predict the dispersion and chemical reactions of pollutants. For air quality models the initial state is determined by the horizontal and vertical distribution of different pollutants in the atmosphere. Satellite measurements of aerosol optical thickness (AOT) can be used in combination with ground based measurements of PM10 to provide highly-resolved initial fields. The combination of previous model forecasts, ground based measurements and satellite observations provides the best possible estimate of the initial distribution of pollutants and is required for a good model forecast. The advanced model system developed in the project is expected to significantly improve the air quality forecasts for Austria, which are currently based on ground observations only. Potential applications of the advanced modelling system include daily air quality forecasts and environmental assessment studies for historical episodes.

### Infobox

#### Project duration:

01 April 2011 – 31 March 2013

#### Coordinator:

Central Institute for Meteorology and Geodynamics  
(ZAMG)

Marcus Hirtl

Hohe Warte 38, 1190 Vienna, Austria

T: +43 (0)1 36026 – 2406

marcus.hirtl@zamg.ac.at

www.zamg.ac.at

#### Partners:

SISTEMA GmbH

Simone Mantovani

www.sistema.at

University of Natural Resources and Life Sciences

Institute of Meteorology

Bernd C. Krüger

www.boku.ac.at

EOX IT Services GmbH

Gerhard Triebnig

www.eox.at



MODIS true colour image over  
Austria. © SISTEMA

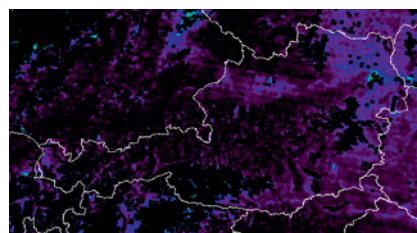

MODIS particulate matter PM2.5  
concentration map over Austria.  
© SISTEMA

# compact-PTR-TOF-MS

## Development of a Compact Time-of-Flight Mass Spectrometer for Suborbital Research on the Earth's Atmospheric Composition

One of NASA's strategic goals is to advance Earth systems science to meet the challenges of climate and environmental change. DISCOVER-AQ (Deriving Information on Surface Conditions from Column and Vertically Resolved Observations Relevant to Air Quality) is a multi-year NASA campaign aimed at improving the use of satellites to monitor air quality (<http://discover-aq.larc.nasa.gov/>). As part of DISCOVER-AQ, NASA deploys two airborne science platforms for remote and in-situ measurements of atmospheric pollutants over selected areas in the US affected by poor air quality.

A research team of the University of Innsbruck was selected to join the DISCOVER-AQ mission to carry out in-situ measurements of atmospheric trace hydrocarbons on board NASA's P-3B Airborne Science Laboratory using the Proton-Transfer-Reaction Mass Spectrometry (PTR-MS) technology developed in Austria. PTR-MS data provide important information on air pollution sources and processes used to improve the interpretation of space-borne observations of air pollutants by current and future satellites.

In this project supported by the Aeronautics and Space Agency of the Austrian Research Promotion Agency, a consortium composed of the University of Innsbruck and Ionicon Analytik (Innsbruck) developed, constructed and validated a compact PTR-TOF-MS instrument for deployment on NASA's airborne science platforms. The time-of-flight (TOF) capability enables continuous measurements of atmospheric hydrocarbons with 1-second time resolution, thus making a ground-breaking contribution to atmospheric composition research, increasing data coverage and improving time resolution by an order of magnitude over previously deployed sensors. In addition, the prototype provides a reduction in size and weight as compared to existing instruments.

The new instrument is scheduled for deployment in NASA's upcoming DISCOVER-AQ missions and is anticipated to create new commercial opportunities for Ionicon Analytik.

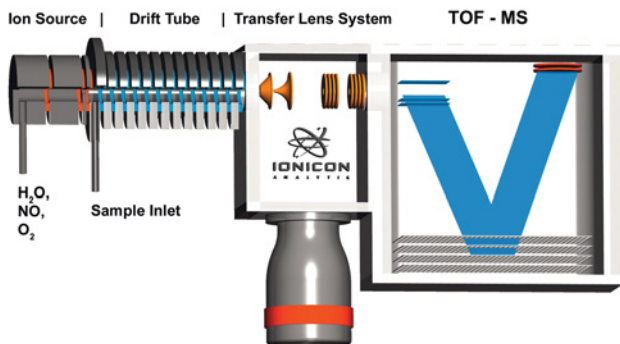

PTR-TOF-MS instrument scheme. © Ionicon Analytik GmbH



NASA's P-3B Airborne Science Laboratory. © NASA

### Infobox

#### Project duration:

01 December 2011 – 30 November 2012

#### Coordinator:

University of Innsbruck  
Institute for Ion Physics and Applied Physics  
Armin Wisthaler  
Technikerstraße 25, 6020 Innsbruck, Austria  
T: +43 (0)512 507 – 6241  
armin.wisthaler@uibk.ac.at  
www.uibk.ac.at

#### Partner:

Ionicon Analytik Gesellschaft m.b.H.  
www.ionicon.com

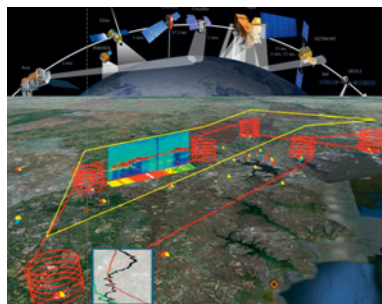

NASA DISCOVER-AQ mission deployment strategy. © NASA



Armin Wisthaler (principal investigator) on board the NASA P-3B. © NASA

# CoReH2O-Science

## Scientific Preparation for the Snow Hydrology Mission CoReH2O

The project contributes to scientific preparations for the satellite mission Cold Regions Hydrology High-Resolution Observatory (CoReH2O). CoReH2O is one of three candidate Earth Explorer Core missions which were selected by ESA for detailed scientific and technical feasibility studies (Phase A) in 2009. One of these missions will be selected for implementation in 2013 and will be launched in 2018. Earth Explorer missions focus on the science and research elements of ESA's Living Planet Programme. CoReH2O will deliver detailed spatial data on key parameters of the global snow and ice masses for applications in climate research and hydrology. The proposed sensor is a dual frequency, X- and Ku-band (9.6 and 17.2 GHz), dual-polarized synthetic aperture radar (SAR). The primary parameters to be delivered by the mission include maps of snow extent, the mass of snow (the snow water equivalent, SWE) on land surfaces and snow accumulation on glaciers. The activities performed in this project complement the Phase-A studies carried out within the ESA Earth Explorer Programme.

The project tasks included contributions to field campaigns on radar measurements of snow, the analysis of these data, the improvement of models for radar backscatter interactions with snow-covered terrain, and the testing and validation of procedures for extracting snow and ice parameters from radar measurements. The figures show results of data analysis from field campaigns conducted in winter 2010/11 and 2011/12 in



Snow cover test site with SnowScat instrument, Arctic Research Centre of the Finnish Meteorological Institute, Sodankylä, February 2012. © ENVEO

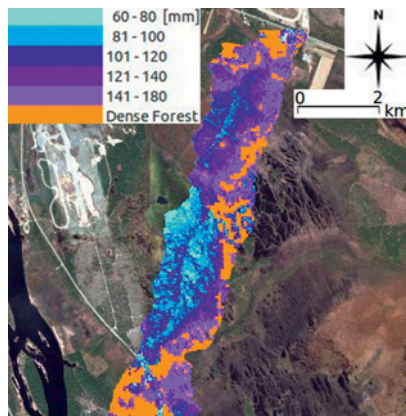

SWE map derived from airborne SnowSAR data, Sodankylä, 15 March 2011, superimposed on Google Earth image. Colour scale: SWE values in mm water equivalent. © ENVEO

### Infobox

#### Project duration:

01 December 2010 – 31 May 2013

#### Coordinator:

ENVEO Environmental Earth Observation IT GmbH  
Helmut Rott, Thomas Nagler  
Technikerstraße 21a, 6020 Innsbruck, Austria  
T: +43 (0)512 50748 – 30  
helmut.rott@enveo.at, thomas.nagler@enveo.at  
www.enveo.at

#### Partner:

EOX IT Services GmbH  
Gerhard Triebnig  
www.eox.at

Northern Finland (Sodankylä) at the test field of the Finnish Meteorological Institute. The SnowScat instrument recorded radar backscatter throughout the winter at the same radar frequencies as the CoReH2O sensor. The time series of snow mass (SWE) retrieved from these data provide the accuracy required for SWE products, as shown by the comparison with in-situ snow measurements. First tests with a new Ku- and X-band SAR sensor (SnowSAR) developed for ESA showed promising results for deriving SWE maps from radar data.

The project was carried out in cooperation with associated international partners:

- > Finnish Meteorological Institute, Helsinki
- > Interdisciplinary Centre on Climate Change, University of Waterloo, Canada
- > Jet Propulsion Laboratory, California Institute of Technology, Pasadena

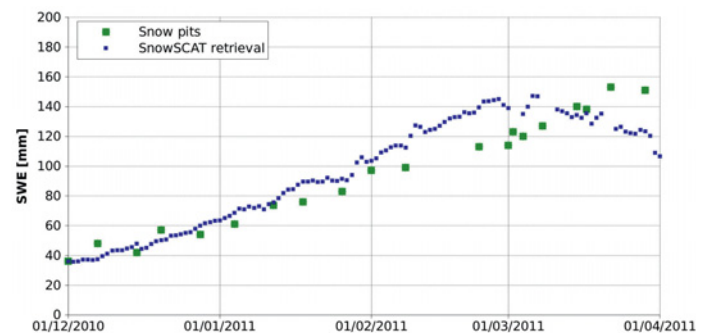

Time series of snow mass (SWE) derived from SnowScat measurements, Sodankylä, winter 2010/11, and SWE measured in snow pits. © ENVEO

# EO4Water

## Application of Earth Observation Technologies for Rural Water Management

In most parts of the world, irrigated agriculture is the main user of freshwater resources. Efficient water management is therefore of essential importance, especially where water scarcity is tangible and will be further stressed by growing urbanization and decreasing annual precipitation. Current irrigation management approaches based only on practical experience and non-quantitative estimation tend to result in oversupply of water with consequent problems related to misuse of water and mobilization of nitrates. More detailed knowledge about the amount of water required by crops in different development stages and climatic conditions is needed to achieve rational water use.

The potentiality of Earth observation (EO) techniques in supporting the management of water resources is being widely recognized. EO4Water aims at improving methodologies to produce maps of crop water requirements at field and district scale by combining information from EO satellites and ground agro-meteorological data. EO4Water focuses on the Marchfeld area, one of the major crop production areas of Austria with more than 40,000 hectares of irrigated land, and includes field experiments to validate methodologies and adapt them to local agricultural conditions. The project will offer innovative management concepts and tools to complement current investments in irrigation infrastructures – such as the Marchfeldkanal Project.

### Economic Importance

Agriculture accounts for around 30 per cent of total water use in Central Europe (up to 60 per cent in the Marchfeld area), and the overall water demand for irrigation is increasing substantially in Germany, France, Austria, and in Eastern European countries such as Hungary, Bulgaria and Romania. The socio-economic importance of irrigated agriculture is considerable. There is a strong need and a potential demand for applications that support efficient water management. Space technologies provide tangible and substantial benefits. They help farmers and decision-makers to use and manage water according to real crop water requirements and thus to optimize production and cost-effectiveness. EO4Water opens up possibilities for technology transfer to other Central European regions and to the Danube river-basin area, which is of great strategic importance for Europe.



### Infobox

#### Project duration:

01 April 2012 – 31 March 2014

#### Coordinator:

University of Natural Resources and Life Sciences  
Institute of Surveying, Remote Sensing and Land Information

Francesco Vuolo

Peter-Jordan-Straße 82, 1190 Vienna, Austria

T: +43 (0)1 47654 – 5135

francesco.vuolo@boku.ac.at

www.eo4water.com

#### Partners:

Betriebsgesellschaft Marchfeldkanal

Wolfgang Neudorfer

www.marchfeldkanal.at

Adcon Telemetry GmbH

Bernhard Pacher

www.adcon.at

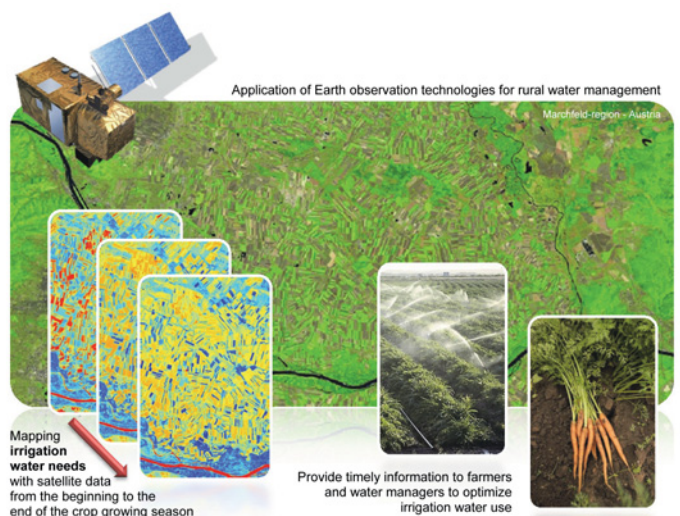

© The satellite: GMES Satellite-2 (ESA); Maps: Landsat TM 5 images (NASA)

# FarmSupport

## Assessing the Potential of Farmer Mobile Information Services for Agricultural Decision Support

FarmSupport aims at developing a proof-of-concept application that will provide farmers in Ethiopia and Kenya with weather forecasts and soil moisture information. This information service is intended to help farmers in making agricultural decisions. Weather information is of value to farmers, but has suffered in the past due to problems with getting the information to the farmer.

To tackle this issue, the application will be delivered via internet and mobile phones, including iPhones. It will also be used to collect crowd-sourced information from the farmers on crops planted, crop yields and fertilizer use by means of a modified Geo-Wiki, thereby promoting two-way communication flow between the data providers (IIASA & ZAMG) and the user (African farmer). The crowd-sourced data will be used to improve the IIASA EPIC crop growth model. Improved crop models could lead to more accurate early warning systems for food security and to better estimates of current yield gaps. The crowd-sourced data represents a potentially unique and valuable dataset for agricultural monitoring, mapping and modelling, and will be freely disseminated via Geo-Wiki. The project will test the information service in two locations: Ethiopia and Kenya.

The key data source underpinning the FarmSupport project is soil moisture derived from the ASCAT sensor, which has become available for Africa through the FFG-funded project Global Monitoring of Soil Moisture for Water Hazards Assessment (GMSM). FarmSupport adds value to GMSM by acting as an additional application that will demonstrate the potential of ASCAT-derived soil moisture. Farmers and the crop modelling team at IIASA will be provided with soil moisture forecasts, which will be obtained from the European Centre for Medium-Range Weather Forecasts (ECMWF) and downscaled by ZAMG, and ASCAT-derived soil moisture.

This project will provide an opportunity to compare these two data sources and evaluate the usefulness of ECMWF soil moisture forecasts as a source of information to farmers and for crop modelling more generally. ZAMG will also compare soil moisture derived from ASCAT with soil moisture from EPIC, and historical forecasts of ECMWF soil moisture with historical soil moisture from EPIC. This research component of the project will address the accuracy of different soil moisture products and the EPIC model.

### Infobox

#### Project duration:

01 March 2012 – 31 August 2013

#### Coordinator:

International Institute for Applied Systems Analysis (IIASA)

Steffen Fritz

Schlossplatz 1, 2361 Laxenburg, Austria

T: +43 (0)2236 807 – 353

fritz@iiasa.ac.at

www.iiasa.ac.at

#### Partner:

Central Institute for Meteorology and Geodynamics (ZAMG)

Alexander Jann

www.zamg.ac.at

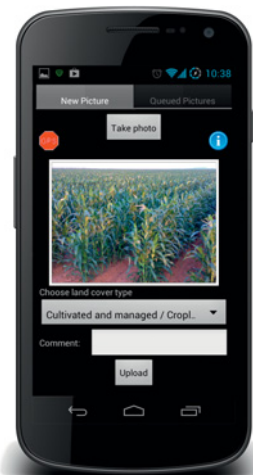

Example: Geo-Wiki mobile app.

© IIASA

# GMSM II

## Global Monitoring of Soil Moisture for Water Hazards Assessment

GMSM II was the follow-up of the GMSM activity performed within ASAP 6. It was launched to advance the use of soil moisture services based on EUMETSAT's MetOp ASCAT sensor and complementary satellite systems. The GMSM II project has successfully accomplished major achievements towards this goal. Soil moisture is now seen to be one of the crucial Earth observation data sets. Within the 8 GEO (Group on Earth Observations) Societal Benefit Areas (SBAs) of Agriculture, Climate, Disasters, Ecosystems, Energy, Health, Water, and Weather, soil moisture is one of only three of the twenty-five highest ranked Earth observation parameters that is seen as a priority for all SBAs.

As the Near Real Time (NRT) ASCAT surface soil moisture (SSM) service heads towards its third year of operation, the SSM product is declared as the second most downloaded product from EUMETSAT's archive. Since the start of GMSM II, project partners have been actively engaged in winning new projects confirming that the scientific donor community (ESA, FFG) critically regards the importance of the monitoring of surface soil moisture. Notably Vienna University of Technology, in conjunction with other partners from GMSM II, have been selected to spearhead a project within ESA's Climate Change Initiative (CCI) establishing soil moisture as one of the 12 Essential Climate Variables (ECV) monitored from space borne systems.

In line with European Global Monitoring for Environment and Security (GMES) projects, GMSM II combines elements of a Core Service with a Downstream Service. The GMSM Core Service encompasses activities related to the further development and validation of satellite soil moisture products. The GMSM Downstream Service tackles the problem of how to translate the soil moisture information provided by the satellites into useful information for decision-makers and the public.

Seven application areas are covered by the GMSM project and include the assimilation of soil moisture data in numerical weather prediction, crop growth and yield, hydrological forecasting, dynamic epidemic modelling, regional climate modelling, relationships and trends of soil moisture, vegetation productivity and land cover and societal risk.

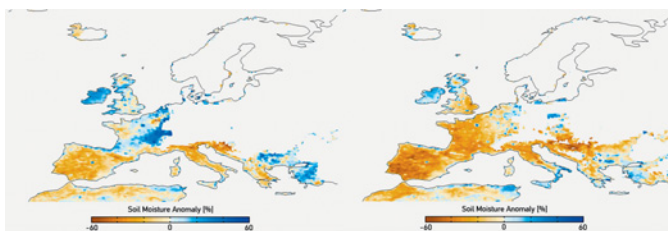

Europe in drought? Soil moisture anomaly (5 year mean) for (left) January and (right) February 2012 shows Spain and Portugal are drier than usual. © Vienna University of Technology

### Infobox

#### Project duration:

01 January 2011 – 31 July 2012

#### Coordinator:

Vienna University of Technology  
Department of Geodesy and Geoinformation  
Wolfgang Wagner  
Gußhausstraße 27-29/120, 1040 Vienna, Austria  
T: +43 (0)1 58801 – 12225  
ww@ipf.tuwien.ac.at  
www.ipf.tuwien.ac.at

#### Partners:

Vienna University of Technology, Institute of Hydraulic Engineering and Water Resources Management  
Günter Blöschl  
www.hydro.tuwien.ac.at

Central Institute for Meteorology and Geodynamics (ZAMG)  
Alexander Jann  
www.zamg.ac.at

University of Natural Resources and Life Sciences  
Institute of Meteorology  
Joseph Eitzinger  
www.wau.boku.ac.at/met.html

University of Veterinary Medicine, Vienna, Biometeorology and Mathematical Epidemiology Group  
Franz Rubel  
www.vu-wien.ac.at/oeffentliches-veterinaerwesen

AIT Austrian Institute of Technology GmbH  
Klaus Steinnocher  
www.ait.ac.at

GeoVille Information Systems GmbH  
Christian Hoffmann  
www.geoville.com

University of Salzburg, Centre for Geoinformatics  
Peter Zeil  
www.zgis.at

# HighSens

## Highly Versatile, New Satellite Sensor Applications for the Austrian Market and International Development

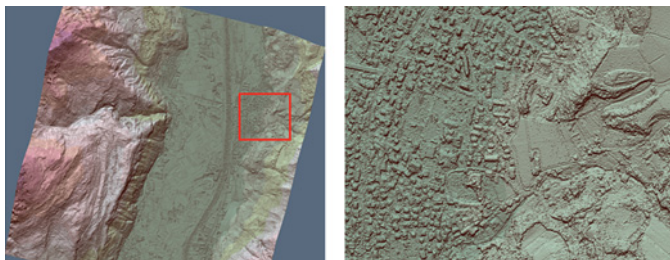

Prototype DSM generated with HighSens 3D Processing Suite. © JOANNEUM RESEARCH

In an era of climate change and economic crisis, governments, international organisations and industry alike make great efforts to improve efficiency by investing in state-of-the-art information and communication technologies. The availability of agile Earth observation sensor data, such as from the Pléiades system, meets a range of high level requirements.

Current land cover mapping projects, the roll-out of LISA and a permanent Austrian land monitoring capacity highly depend on savings in image data acquisition and the consecutive availability of up-to-date, nationwide very high resolution (VHR) image data coverage. The current technological level of aerial imagery in combination with airborne laser scanning for land cover mapping applications were raised to a stand-alone satellite-based monitoring capacity.

### Objectives of HighSens

HighSens, funded by the Austrian Research Promotion Agency under ASAP 8 and supported by the governments of Salzburg and Tyrol, responds to the user requirements for cost-effective and readily available geo-information with the capacities of Pléiades, resulting in an innovative Pléiades 3D Processing Suite. The software enables the generation of digital surface and elevation models (DSM/DEM/nDSM) from Pléiades tri-stereo data, vastly improving horizontal accuracy. In combination with post-orthorectified multi-spectral tri-stereo imagery of the same date, such accurate elevation data allows fully automated analyses and provides a crucial new capacity for VHR land cover monitoring worldwide. HighSens service applications were demonstrated for disaster management (e.g. forestry storm assessment) and rapid infrastructure assessments. Compared to traditional, multi-source information gathering, the new single source solution enables production of highly accurate geo-information products at reduced time and cost, serving many applications of public interest.

In summary, the objective of HighSens was to develop a software tool to generate highly accurate 3D information based on the Pléiades system for the production of multi-parameter information solutions needed in urban and forest mapping applications.

### Infobox

#### Project duration:

01 December 2011 – 30 September 2012

#### Coordinator:

GeoVille Information Systems GmbH  
Wolfgang Stemberger  
Sparkassenplatz 2, 6020 Innsbruck, Austria  
T: +43 (0)512 562021  
stemberger@geoville.com  
www.geoville.com

#### Partner:

JOANNEUM RESEARCH Forschungsgesellschaft mbH  
DIGITAL - Institute for Information and Communication Technologies (JR-DIG)  
Johannes Raggam  
www.joanneum.at

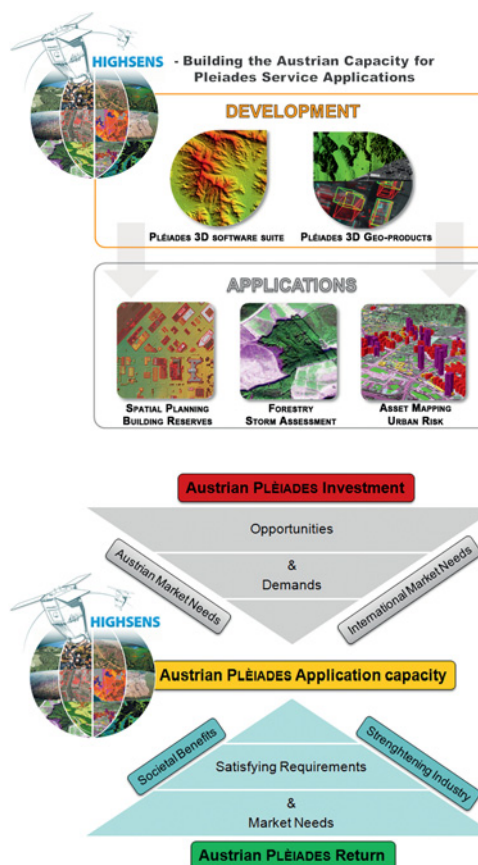

Aimed capacity results of the HighSens developments.  
© GeoVille

HighSens, generating innovative Pléiades capacities to satisfy market requirements.  
© GeoVille

# LandSpotting

## Collecting In-situ Data for Earth Observation Product Validation via Social Games

At present there is no single satellite-derived global land cover product that is accurate enough to provide reliable estimates of forest or cropland area. This project aimed to improve the quality of land cover information by vastly increasing the amount of in-situ data available for calibration and validation of satellite-derived land cover. Land cover is an Essential Climate Variable (ECV), which is required to support the work of the United Nations Framework Convention on Climate Change (UNFCCC) and the Intergovernmental Panel on Climate Change (IPCC). All ECVs are technically and economically feasible for systematic observation. These climate variables require international exchange for both current and historical observations.

The Geo-Wiki system currently allows users to compare three satellite-derived land cover products and validate them using Google Earth. However, there is presently no incentive for anyone to provide this data so the amount of validation through Geo-Wiki has been quite limited so far. The LandSpotting project takes a truly innovative approach by adding crowdsourcing through the development of games. The games engage users whilst simultaneously collecting a large amount of in-situ land cover information. The development of the games was informed by the current raft of successful social gaming.

At the same time, the Geo-Wiki system was modified to exploit the latest available satellite images and to use the in-situ validation data, which is also collected via [competition.geo-wiki.org](http://competition.geo-wiki.org), to create new outputs:

- > A hybrid land cover map, which takes the best information from each individual product to create a single integrated version
- > A database of validation points that will be freely available to the land cover user community
- > A facility that allows users to create a specific targeted validation area, which will then be provided to the crowdsourcing community for validation

These outputs will turn Geo-Wiki into a valuable system for many land cover users.



Geo-Wiki validation points: Volunteers from around the globe can classify Google Earth imagery, and input their agreement/disagreement with the existing data. © IIASA

### Infobox

#### Project duration:

01 February 2011 – 31 October 2012

#### Coordinator:

International Institute for Applied Systems Analysis (IIASA)

Steffen Fritz

Schlossplatz 1, 2361 Laxenburg, Austria

T: +43 (0)2236 807 – 353

[fritz@iiasa.ac.at](mailto:fritz@iiasa.ac.at)

[www.iiasa.ac.at](http://www.iiasa.ac.at)

#### Partners:

FOTEC Forschungs- und Technologietransfer GmbH

Martina Dürauer

[www.fotec.at](http://www.fotec.at)

EOX IT Services GmbH

Gerhard Triebnig

[www.eox.at](http://www.eox.at)

Vienna University of Technology

Institute of Computer Graphics and Algorithms

Michael Wimmer

[www.tuwien.ac.at](http://www.tuwien.ac.at)



LandSpotting games.

© IIASA





Land cover and land use maps (left to right: orthophoto 2009 – land cover map – land use map).  
© JOANNEUM RESEARCH, State of Carinthia

Austria can build on a long experience in land cover and land use (LC/LU) monitoring. However, these datasets have been produced with different standards, lack comparability or are outdated in most cases.

The development of the Land Information System Austria (LISA) was initiated within ASAP 6 and continued within ASAP 7 to overcome the shortcomings of the existing LC/LU datasets for regional, national as well as European management and reporting requirements. The development was implemented as a three-stage process: concept phase (2009 – 2010), completion phase (2010 – 2012) and roll-out phase (from 2012).

The concept phase achieved a consensus among the stakeholders, users and the scientific/technical community about the specifications for the new Austrian LC/LU data model and land monitoring system. In an iterative process, a technically feasible requirements catalogue and data model were established, processing chains developed, prototypes produced and verified, and the costs determined. The concept phase provided demonstration prototypes covering a total of 49 diverse test sites (> 3,000 km<sup>2</sup>), a user-defined, technically feasible and scientifically verified requirements catalogue as well as an architecture and data model for implementation.

The completion phase developed critical components enabling the operational roll-out of LISA as a national and operational monitoring solution. These included establishment of the data model in a physical database, the implementation of a fully automated change detection and upscaling method (spatial aggregation to European level) and the demonstration of LISA for the usage in spatial planning applications.

The roll-out phase has already been initiated through single initiatives of regional governments which financed land cover/land use data production according to LISA specifications for part of their territory. This represented a major achievement in making LISA a sustainable user accepted standard. Nevertheless, the ultimate vision is to initiate single funded, country-wide roll-out to fulfil the initial user requirements for a homogenous and operational land monitoring system for Austria.



Change detection (left to right: orthophoto 1999 – orthophoto 2008 – recognized changes).  
© GeoVille, State of Tyrol

### **Infobox**

#### **Project duration:**

01 May 2009 – 29 June 2012

#### **Coordinator:**

GeoVille Information Systems GmbH  
Andreas Walli  
Sparkassenplatz 2, 6020 Innsbruck, Austria  
T: +43 (0)512 562021 – 0  
walli@geoville.com  
www.geoville.com

#### **Partners:**

AIT Austrian Institute of Technology GmbH  
Klaus Steinnocher  
www.ait.ac.at

JOANNEUM RESEARCH Forschungsgesellschaft mbH  
DIGITAL - Institute for Information and Communication  
Technologies (JR-DIG)  
Mathias Schardt  
www.joanneum.at

Graz University of Technology  
Institute of Remote Sensing and Photogrammetry  
Rainer Prüller  
www.geoimaging.tugraz.at

University of Natural Resources and Life Sciences  
Institute of Surveying, Remote Sensing and Land  
Information  
Reinfried Mansberger  
www.boku.ac.at

Umweltbundesamt - Environment Agency Austria  
Gebhard Banko  
www.umweltbundesamt.at



# PRESENT

## Preparing for the ESA Sentinel Missions

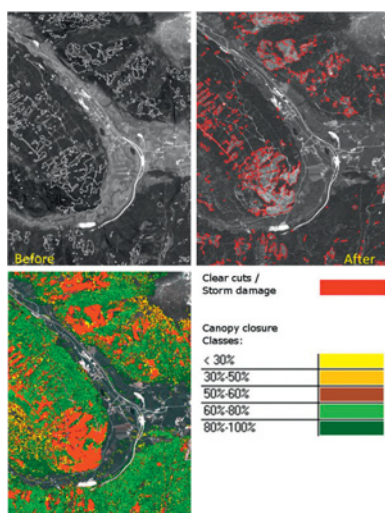

Forest monitoring application including change detection (top) and classification of canopy closure (bottom) using Spot image data acquired in 1987 and 2003.  
© JOANNEUM RESEARCH

The Sentinel satellite family is the flagship of Earth observation satellites operated by ESA and EC and provides the continuity for operational monitoring of the environment and climate using optical and microwave satellite data for the next decades. Various types of ground segments are implemented to provide information from Sentinel satellites for public use. Acquisition, processing, archiving and validation of the large amount of Sentinel data is organized in Core Ground Segments implemented by ESA. They are supported by Mission Performance Centres, providing calibration, validation, quality control, or end-to-end system performance assessments. These segments are complemented by Collaborative Ground Segments, installed at national and regional level in order to provide higher level products and services based on Sentinel data sets.

The project is aimed at developing technical concepts in preparation for a potential involvement into the above opportunities. The technical developments of the project thus refer to:

- > Evolution of data processing algorithms
- > Development of quality assessment procedures for Sentinel core products
- > Development of advanced methods for the derivation and monitoring of alpine land use and land cover maps for alpine regions
- > Development of innovative algorithms to generate snow and glacier products from multi-sensor Sentinel data, and methods for data assimilation and product validation
- > Demonstration applications to generate land use, change detection, snow and glacier products using simulated Sentinel data sets

Simulations of optical as well as SAR (Synthetic Aperture Radar) Sentinel image data kindly provided by ESA are used for the developments and investigations in the project, which builds on

### Infobox

#### Project duration:

01 April 2012 – 31 March 2014

#### Coordinator:

JOANNEUM RESEARCH Forschungsgesellschaft mbH  
DIGITAL - Institute for Information and Communication Technologies (JR-DIG)

Mathias Schardt

Steyrergasse 17, 8010 Graz, Austria

T: +43 (0)316 876 – 1735

DIGITAL-FER@joanneum.at

www.joanneum.at

#### Partner:

ENVEO Environmental Earth Observation IT GmbH

Thomas Nagler

www.enveo.at

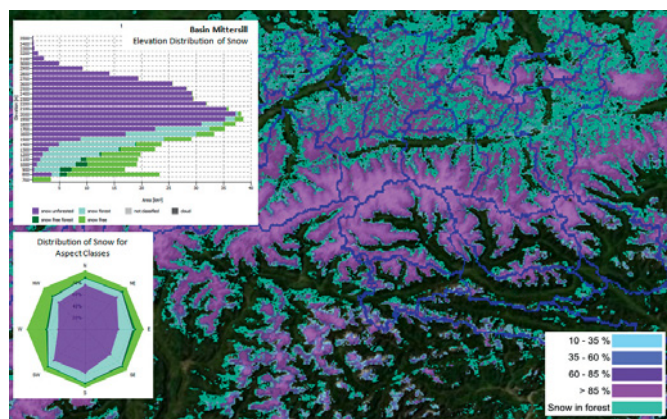

Fractional snow map covering the Alps, 27 February 2012, from medium resolution multi-spectral optical data and statistical snow information for the Mittersill Basin. © ENVEO

previous national projects like ASAG or Triple-M. Dedicated concepts with respect to the establishment of a Quality Assessment Expert Laboratory or a Collaborative Ground Segment are further elaborated.

Apart from the opportunities mentioned above, the project developments will be of benefit for ongoing GMES-related activities of the project partners, such as GEOLAND-II, EUFODOS and CryoLand, as well as for future national and international research contracts.

# RAPIDEM

## Rapid Assessment Provision for Intelligent Disaster and Emergency Management

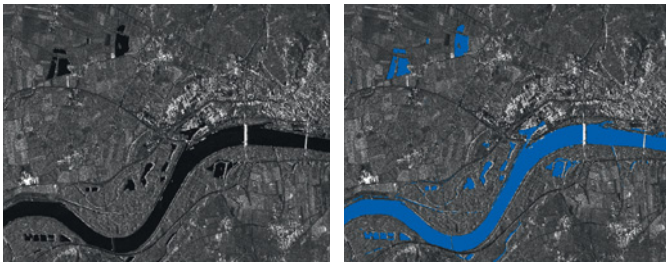

RAPIDEM prototype results of near real-time TerraSAR-X based water body detection.  
© GeoVille

The numerous large- and small-scale natural disasters that have occurred in Austria, Europe and worldwide in the past have prompted disaster relief organisations to improve their crisis management capabilities by using innovative communication and information technologies. Valuable image information for instance can be gathered on-demand from satellite and airborne remote sensing systems. Along with existing geo-databases, spatial information of the situation on the ground can be rapidly and objectively provided to disaster management organisations. This project aimed at the development of information products and service structures supporting critical decision-making processes in flood disaster management for the Austrian disaster relief organisations. Time-critical data and information generation are a major factor in successful disaster management.

The project integrates both the existing satellite TerraSAR-X near real-time service and an airborne multi-sensor data acquisition platform developed by JOANNEUM RESEARCH, which may include optical, thermal or infrared cameras, in order to ensure rapid data availability and an efficient support of decision processes in different emergency situations. New information products based on a combination of these different data sources and an optimized ordering, processing and management system are designed to provide Austrian decision-makers with a comprehensive and seamless service for emergency management.

A strong focus on interoperability and modularity ensures that these developments can be rapidly expanded and integrated into existing systems. The services developed are coordinated with the Austrian National Crisis and Disaster Protection Management (SKKM 2020) strategy and are tailored to the requirements of the User Executive Board of the project, which includes representatives from the regional governments of Styria and Lower Austria as well as additional experts in the field of emergency and crisis management.

### Infobox

#### Project duration:

01 January 2012 – 31 December 2012

#### Coordinator:

JOANNEUM RESEARCH Forschungsgesellschaft mbH  
DIGITAL - Institute for Information and Communication  
Technologies (JR-DIG)

Hannes Raggam

Steyrergasse 17, 8010 Graz, Austria

T: +43 (0)316 876 – 1735

DIGITAL-FER@joanneum.at

www.joanneum.at

#### Partners:

GeoVille Information Systems GmbH

Andreas Walli

www.geoville.at

Vienna University of Technology

Department of Geodesy and Geoinformation

Markus Hollaus

www.ipf.tuwien.ac.at



Top: airborne data acquisition.

Bottom (left): optical image with marked flooded area.

Bottom (right): thermal data showing critical water dam wetness.

© JOANNEUM RESEARCH



# Navigation

**CrashPos**

**FLIXDATE**

**GIOMO**

**I-Game NG**

**LOPT-GNSS**

**NAVWAT 2**

**PPP-Serve**

**PURSIT**

**RT-PPP**

**SoftGNSStrusted**

# CrashPos

## Single-frequency RTK for an Advanced Driver Assistance System Test Bed

Road traffic injuries are the leading cause of death among young people. People referred to as "vulnerable road users" such as pedestrians or cyclists are especially at risk. As a result, one of the major tasks within automotive industry is to enhance Advanced Driver Assistance Systems (ADAS) which support the driver in critical situations. Examples of ADAS are pedestrian detection systems or emergency brake assistants.

The increasing importance of ADAS in the car industry also requires the development of control modules designed to facilitate the test process of these systems with a special focus on realistic tests. Such a test system usually consists of a test vehicle, one or more dummy platforms and a control server. One very important part of the test system is the accurate positioning and guidance of the vehicles involved, which is generally solved with Global Navigation Satellite Systems (GNSS).

Currently available test systems are based on high-cost positioning equipment. The scope of this project is to use reasonably priced positioning components as well as a unique dummy platform called UFO (Ultraflat Overrunnable Obstacle), which was developed by Dr. Steffan – Datentechnik Gesellschaft m.b.H.. The UFO platform can be used to simulate accident scenarios, e.g. with pedestrians. It is also flat enough to be overrun by a standard car, thus preventing vehicle damage. To meet the price and size restrictions, a single-frequency Real Time Kinematics (RTK) solution, a relative GNSS technique, will be calculated on board the test vehicle and the dummy platform(s).

The vehicle motions are highly kinematic – up to 80 km/h are expected. Special challenges of the project include mounting the flat antenna on the UFO, satellite shadowing and multipath as well as meeting the accuracy requirements with low-cost equipment. The relative RTK solution will thus be integrated with inertial measurements, which are essential to increase the update rate and improve the position solution received from relative GNSS measurements. The final trajectory positions will be sent to a control server to enable supervising the test of the specific ADAS module in real time.



UFO with dummy.

© Dr. Steffan – Datentechnik Gesellschaft m.b.H.

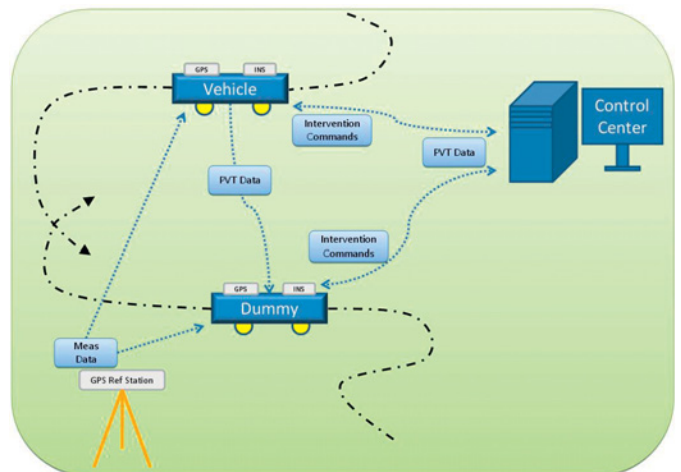

CrashPos system design. © Institute of Navigation, Graz University of Technology

### Infobox

#### Project duration:

01 March 2012 – 31 August 2013

#### Coordinator:

Graz University of Technology

Institute of Navigation

Roman Lesjak

Steyrergasse 30, 8010 Graz, Austria

T: +43 (0)316 873 – 6832

roman.lesjak@tugraz.at

www.inas.tugraz.at

#### Partners:

Alpen-Adria-Universität Klagenfurt

Institute for Smart-Systems Technologies

Vamsi Prakash Makkapati

www.uni-klu.ac.at/tewi/ict/sst

Dr. Steffan – Datentechnik Gesellschaft m.b.H.

Andreas Moser

www.dsd.at

# FLIXDATE

## Floating Ski Data by GNSS

The FLIXDATE project intends to develop a demonstration system for alpine ski sport traffic analysis, traffic routing and collision avoidance on ski slopes. Detection of dangerous zones and management of ski traffic based on floating ski data lead to increased safety and traffic performance on ski slopes.

Given the dramatic increase in ski lift capacities in recent years, the topic of skiing safety is of growing importance. Modern chair lifts are able to carry several thousands of people per hour resulting in a dramatically increased density of people on the slopes. Skiers are also travelling at high and often uncontrolled speeds due to huge improvements in material and ski design, which has led to a sharp rise in the number of accidents, including many fatalities. The motivation of this project is therefore to reduce alpine skiing accidents significantly and to enhance comfort on slopes.

The collection of floating ski data is based on GNSS as a positioning source and smart phones for data acquisition and transmission. For this purpose the skiing resort provides the rental of preinstalled outdoor phones and the download of an application (app) onto private phones. In a later development stage additional features are added to attract users, for example a map of the skiing resort, evaluation of the personal skiing day and outdoor games.

The collected data is sent via WLAN hot spots to a central server where the data is stored in a database. For optimum position performance EDAS (EGNOS Data Access System) data are obtained via PANDAS (Positioning and Navigation Data Assistance Service) to augment the position solution and to obtain more accurate position and speed information. Once Galileo will be available, the system will benefit from the increased number of visible satellites since slopes are often north facing.

Data evaluations are used to mark geo-referenced areas within the skiing resort classified as high risk and to generate near real-time information. This information can be used to secure dangerous zones and to guide skiers to non-crowded areas using information screens and electronic traffic signs, thus managing skier traffic throughout the skiing area.

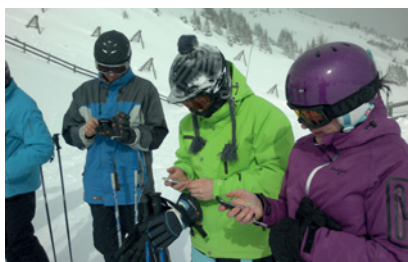

Impression of test data acquisition.  
© Johannes Vallant

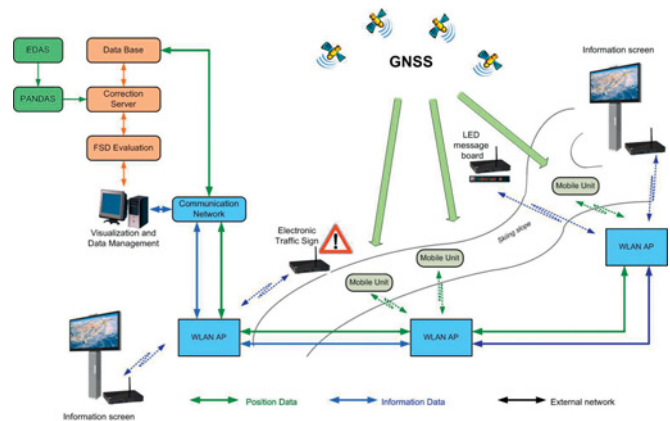

Schematic representation of the FLIXDATE system architecture. © FLIXDATE consortium

### Infobox

#### Project duration:

01 January 2012 – 30 June 2013

#### Coordinator:

TeleConsult Austria GmbH  
Philipp Berglez  
Rettenbacher Straße 22, 8044 Graz, Austria  
T: +43 (0)316 890971 – 14  
pberglez@tca.at  
www.tca.at

#### Partners:

GeoMatica – Dipl.-Ing. Johannes Vallant  
Johannes Vallant  
www.geomatica.at

EDS EnergyData Software OG  
Günther Abwerzger  
www.energydata.at

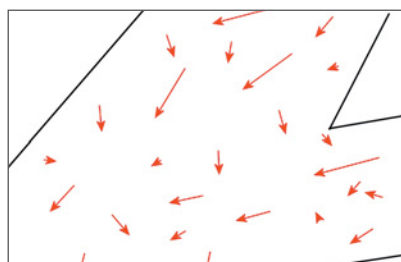

Schematic representation of the floating ski data algorithm.  
© EDS EnergyData Software OG

# GIOMO

## Next Generation Near Real-time Ionospheric Models

The objectives of the GIOMO (next Generation near real-time Ionospheric Models) project were the identification and consolidation of improved ionospheric modelling technologies, the software implementation of a selected refined model, and the final integration into the existing OEGNOS (Austrian EGNOS data server) software in order to improve the positioning accuracy for this augmentation service and thus to foster user acceptance. The project therefore started with a state-of-the-art analysis including a general description of the physical effects and the structure of the ionosphere between the GNSS satellites and the Earth's surface with a focus on the TEC (Total Electron Content) as major observable, and an analysis of different existing observation methods and networks. Based on these analyses, a survey and comparison of existing models were carried out, including possible refinement approaches. This led to the selection of the candidate model to be implemented, including refinement as pseudo-code and ionospheric model software module. The near real-time model OLG RIM (Observatory Lustbühel Graz Regional Ionospheric Map) was chosen from code measurements based on investigations in terms of statistics, stability, temporal and regional flexibility as well as availability.

Subsequently, the software module was integrated into the OEGNOS software, replacing the standard model currently used, in order to improve service accuracy. NeQuick was implemented as a backup model.

The OEGNOS software is an EGNOS-based augmentation service providing "improved" EGNOS correction to users via a terrestrial communication link. To enable the service for commercial off-the-shelf receivers without modifications, the standardized Ntrip protocol was chosen for communication between OEGNOS server and receiver.

Finally, static and kinematic tests were carried out using a test user terminal in order to analyse the accuracy gain achieved by the refined ionospheric model.

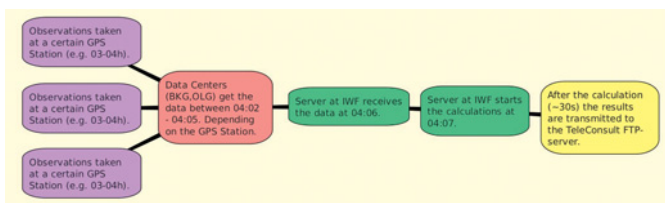

Flowchart of the near real-time process. © IWF

### Infobox

#### Project duration:

01 January 2011 – 31 May 2012

#### Coordinator:

TeleConsult Austria GmbH  
 Albert Kemetinger  
 Rettenbacher Straße 22, 8044 Graz, Austria  
 T: +43 (0)316 890971 – 10  
 akemetinger@tca.at  
 www.tca.at

#### Partners:

Vienna University of Technology  
 Institute of Geodesy and Geophysics  
 Robert Weber  
 www.hg.tuwien.ac.at

Austrian Academy of Sciences  
 Space Research Institute (IWF)  
 Walter Hausleitner  
 www.iwf.oeaw.ac.at



GIOMO: next Generation near real-time Ionospheric Models. © TeleConsult Austria

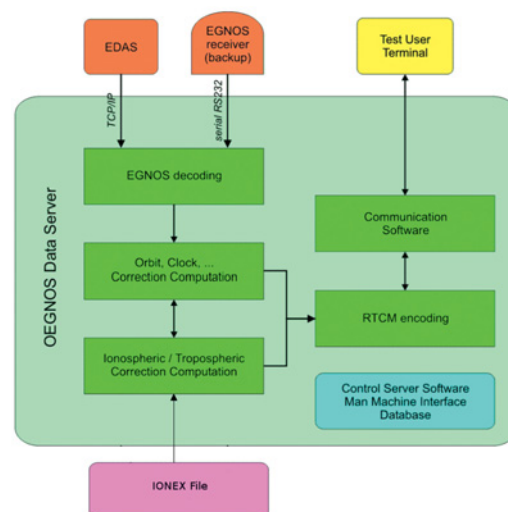

System architecture of the GIOMO project. © TeleConsult Austria

# I-Game NG

## Integrated Telemetry and GIS-System for Wildlife Management Next Generation

Wildlife monitoring provides valuable information for a wide range of socio-political, ecological and economic issues. Major application areas include reduction of wildlife accidents, planning of large infrastructure projects, reduction of forest damage, and wildlife biology research.

Current wildlife telemetry systems using collar transmitters have the disadvantage of disturbing the animals' behaviour and of being costly in terms of required resources. Newly developed systems based on GPS and GSM technology still have a relatively low data rate due to a restricted energy supply. The project is thus aimed at developing a telemetry system based on GPS and GSM technology which provides generally higher data rates due to additional energy generation on the animal. A camera mounted on the telemetry collar provides additional significant information on the animal's behaviour. In order to identify the location, residence time and movement patterns of animals and precisely analyse their habitat requirements, all essential spatial information (existing maps, results from satellite and aerial photo interpretation, GPS points, digital elevation model etc.) is integrated into a Geographical Information System (GIS). This enables automatic calculation of statistics on habitat use and visualization of integrated information.

A major project outcome will be a concept for small series production of the telemetry collar for wildlife monitoring as well as one enhanced test collar based on satellite navigation (GPS, Galileo), telecommunication and data transmission modules (GSM, WLAN, satellite), a camera and various sensor devices.

### Infobox

01 November 2011 – 30 April 2013

#### Coordinator:

JOANNEUM RESEARCH Forschungsgesellschaft mbH  
DIGITAL - Institute for Information and Communication  
Technologies (JR-DIG)

Heinz Mayer

Steyrergasse 17, 8010 Graz, Austria

T: +43 (0)316 876 – 1721

heinz.mayer@joanneum.at

[www.joanneum.at/en/digital/mva.html](http://www.joanneum.at/en/digital/mva.html)

#### Partners:

WWN Wildökologische Waldwirtschaftliche Naturräumliche  
Planung & Beratung

Martin Forstner

[www.wwn-forstner.at](http://www.wwn-forstner.at)

Prototypenbau Meister

Norbert Meister

Graz University of Technology

Institute of Remote Sensing and Photogrammetry

Mathias Schardt

[www.geoimaging.tugraz.at](http://www.geoimaging.tugraz.at)



Telemetry collar immediately before evaluation. © I-Game NG



On game habitat capture. © I-Game NG



# LOPT-GNSS

## Hose Line Optimisation by GNSS



Forest fire in difficult terrain. © GeoMatica

A special challenge for fire brigades operating in difficult terrain and exposed locations consists in pumping water to the forest fire or burning building. In the case of extreme hose line lengths, each section of the hose line is supplied by a single water pump. Frequently problems arise due to the improper set-up of the numerous water pump locations.

The LOPT-GNSS (Hose Line Optimisation by GNSS) project set out to develop a demo system which guarantees fast and efficient advancement of hose lines. For long-distance hose lines the locations of water pumps need to be determined according to hose line lengths, altitude differences and pump power. The misinterpretation of topography and time restrictions for the calculation process often made water supply impossible in the worst case.

LOPT-GNSS developed special software for an outdoor smartphone based on an in-depth evaluation of different hardware platforms. Satellite navigation delivers accurate position information, which is augmented by a specially developed sensor box including a Bluetooth-capable barometer/compass. Based on these co-ordinates the innovative software calculates the most suitable locations for the individual pumps in real time.

A graphic user interface with geographic map data and interactive buttons was developed according to user requirements to enable error-free planning and secure guidance. The calculated pump locations are wirelessly transmitted to other fire fighter teams, who can navigate to the locations and complete the hose lines. The LOPT-GNSS system reduces staff requirements, ensures safe guidance in rough terrain and guarantees faster and more efficient water supply for fire-fighting.

The LOPT-GNSS project was carried out by a consortium of SMEs and a scientific institution, professionals in the fields of mechatronics, navigation, geo-information and fire-fighting technology.

### Infobox

01 February 2012 – 31 May 2013

#### Coordinator:

GeoMatica – Dipl.-Ing. Johannes Vallant  
Johannes Vallant  
Weiberfelderweg 14g, 8054 Graz, Austria  
T: +43 (0)316 282626  
j.vallant@geomatica.at  
www.geomatica.at

#### Partners:

Graz University of Technology  
Institute of GEOinformation  
Norbert Bartelme  
www.geoinformation.tugraz.at

Autohaus Josef Lang  
Markus Lang  
www.fordlang.at



Fire-fighting during nighttime. © J. Vallant



Destroyed vegetation in alpine region after forest fire. © A. Holawat

# NAWWAT 2

## Future High Precision Navigation System for Inland Waterways 2

NAWWAT 2 was a follow-up project of NAVWAT funded within ASAP 6. The main objective of NAVWAT 2 was the development of an innovative navigation system for inland waterway vessels to help reduce the risk of collisions with infrastructure along the rivers.

The system concept developed in NAVWAT supports the crew of inland vessels in navigating in narrow surroundings, e.g. in the vicinity of locks, bridges and in harbours. The concept uses modern Global Navigation Satellite System (GNSS) and augmentation infrastructure to provide precise information such as accurate position, velocity and integrity information to the vessel crew. The crew is thus continuously updated on the accurate distance between the hull of the vessel and the riverside infrastructure.

This guarantees that the crew will judge critical navigation situations correctly and reduces risk of collisions with infrastructure. Such applications enable the vessel master to take faster decisions and maximize the quality of Inland Water Transport (IWT) service.

In order to achieve the required navigation performance, NAVWAT 2 needs a modernized GNSS infrastructure – a technology that is not yet available. Nevertheless, the key innovations can already be demonstrated using the existing GNSS infrastructure, including integration with existing inland navigation technologies such as the Inland Automatic Identification System (AIS) and the Inland Electronic Chart Display and Information System (ECDIS). The pilot implementation of the developed system concept was tested on the Danube in the Vienna area.

NAWWAT supports the goals of Directive 2005/44/EC on harmonized River Information Services (RIS), where one focus lies on optimizing the use of the infrastructure and improving safety on European waterways.

### Infobox

#### Project duration:

01 January 2011 – 31 October 2012

#### Coordinator:

TeleConsult Austria GmbH

Klaus Aichhorn

Schwarzbauerweg 3, 8043 Graz, Austria

T: +43 (0)316 890971 – 12

klaus.aichhorn@tca.at

www.tca.at

#### Partners:

via donau – Österreichische Wasserstraßen-Gesellschaft mbH

Johannes Nemeth

www.via-donau.org



Impressions of different inland vessels. © via donau



Barge convoys in a lock during locking manoeuvre. © via donau

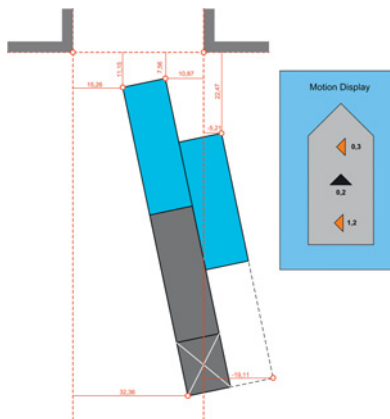

Symbolic representation of the NAVWAT 2 application visualization. © via donau

# PPP-Serve

## Network Based GNSS Phase Biases to Enhance PPP Applications – A New Service Level of GNSS Reference Station Provider

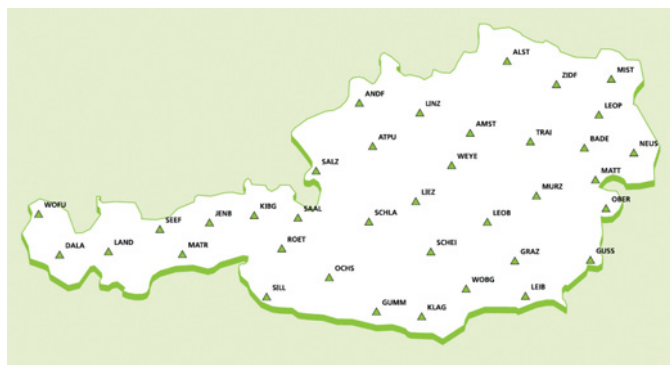

EPOSA GNSS station network. © PPP-Serve

The PPP-Serve project aims at the development and realization of adequate algorithms to enhance fast GNSS based point positioning at cm level. Regularly established RTK (Real Time Kinematic) techniques are based on building and processing observation differences while the required observation corrections are forwarded to the user community in standardized RTCM format. In contrast to the differencing technique, the PPP (Precise Point Positioning) model is based on code/phase single point positioning, which requires a limited amount of correction data by transferring model parameters instead of observation corrections. Leading manufacturers have agreed on a new RTCM standard (RTCM 3.2, State Space Representation = SSR) which supports PPP. New receiver hardware and software issued from 2012 onwards will be capable to process this standard. GNSS service providers must thus adapt to this situation by offering new service levels. Unfortunately global SSR information like satellite orbit and clock correction models do not allow for phase ambiguity resolution in real-time and therefore PPP still suffers from long convergence times (10-30 minutes).

In a further step PPP-Serve aims at the provision of so-called satellite phase biases which are the missing link at user side to allow for PPP-based phase ambiguity resolution. Applying relevant satellite phase biases will reduce the convergence times down to a few seconds. Both currently known techniques for establishing these phase biases will be investigated. Software to determine these parameters from the observation data of the regional GNSS service provider EPOSA will be established. Finally these parameters are forwarded to the user community in a proprietary format as a new service level.

Aside from GPS based positioning, the project also addresses the aspect of how to use GLONASS satellite signals and the processing of relevant GLONASS phase biases. Investigations concerning Galileo IOV (In-Orbit Validation) signals depend on the availability of the IOV signals during the project life span.

### Infobox

#### Project duration:

01 April 2012 – 30 September 2013

#### Coordinator:

Vienna University of Technology  
 Institute of Geodesy and Geophysics  
 Robert Weber  
 Gußhausstraße 27-29, 1040 Vienna, Austria  
 T: +43 (0)1 58801 – 12865  
 robert.weber@tuwien.ac.at  
 info.tuwien.ac.at/hg

#### Partners:

Graz University of Technology, Institute of Navigation  
 Katrin Huber  
 www.inas.tugraz.at

WIEN ENERGIE Stromnetz GmbH  
 Christian Klug  
 www.wienenergie.at

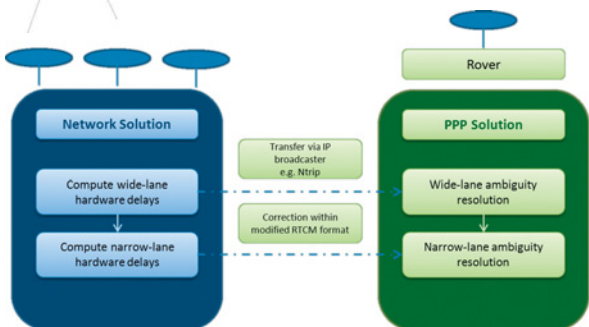
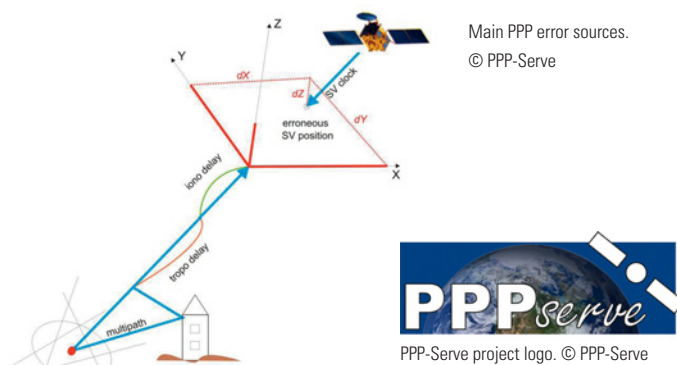

Uncalibrated Hardware Delays (UHD) broadcasting scheme. © PPP-Serve

# PURSIT

## Galileo Public Regulated Service Signal Simulation and Position, Velocity, and Time Calculation

The European global navigation satellite system Galileo has been designed using a service-oriented approach with a focus on five main services. One of these services is the Public Regulated Service (PRS), which is to provide a higher level of protection against threats to the Galileo signals in space (SIS) and hence increase the probability of continuous availability of the SIS in the presence of interfering threats such as jamming and spoofing. Access to the PRS is controlled by the European Union and its member states by encrypting the transmitted signal. The primary users of the PRS will be law enforcement units including the police, special ops and customs, emergency services like fire brigades and ambulances as also space agencies for use in the positioning of spacecraft.

The European Commission stated that Galileo will provide two services at initial operational capability: the Open Service and the PRS. To be able to assess the performance of the PRS, a signal simulator software module is developed within the PURSIT project. It will jointly simulate the PRS navigation message on the two carrier frequencies and generate a digital intermediate frequency signal. To avoid confidentiality constraints, dummy messages and open access encryption standards will be implemented. For the development of the simulator, the consortium can rely on the software GIPSIE® (GNSS multisystem performance simulation environment) previously developed by TeleConsult Austria GmbH.

Moreover, a PRS position, velocity, and time calculation software module is designed to compute position information based on the simulated data. Closed-loop simulations will be used to analyse the performance regarding positioning accuracy, availability, and integrity of the PRS signals. In parallel to the technological development, the project also involves analysing the potential market in Austria for the PRS signal simulator, the PRS receiver, and for PRS in general and establishing an appropriate business model.

### Infobox

#### Project duration:

01 March 2012 – 31 January 2014

#### Coordinator:

TeleConsult Austria GmbH

Philipp Berglez

Rettenbacher Straße 22, 8044 Graz, Austria

T: +43 (0)316 890971 – 14

pberglez@tca.at

www.tca.at

#### Partners:

BRIMATECH Services GmbH

Susanne Fuchs

www.brimatech.at

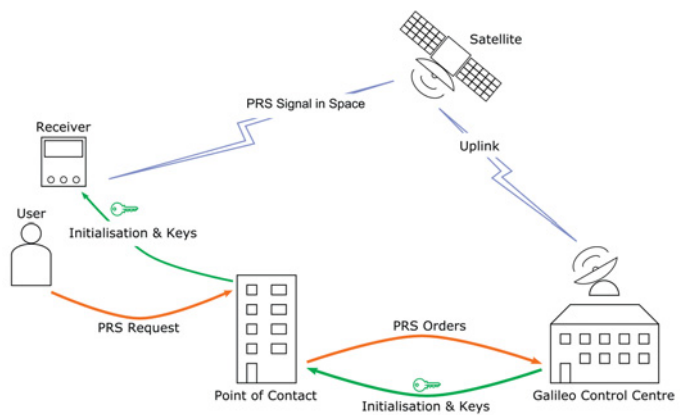

Public Regulated Service functionality. © TeleConsult Austria GmbH

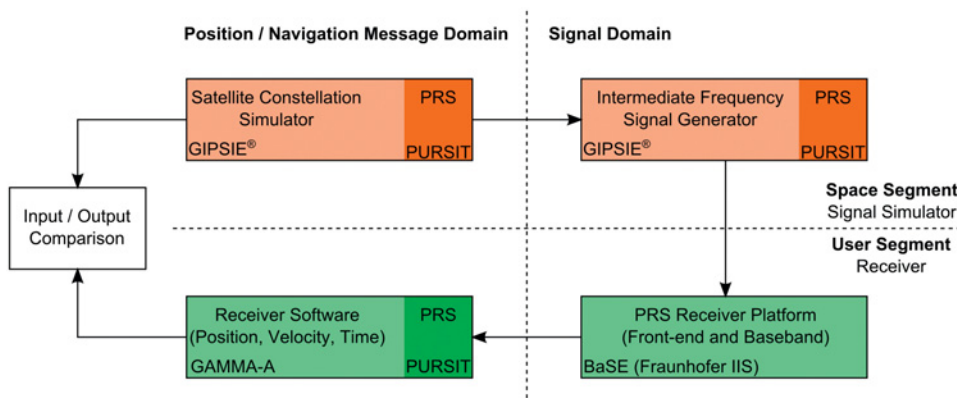

PURSIT system architecture. © TeleConsult Austria GmbH

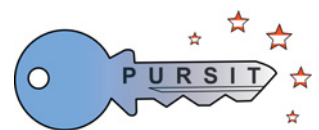

PURSIT logo. © TeleConsult Austria GmbH

# RT-PPP

## Development of a Real-time PPP Processing Facility

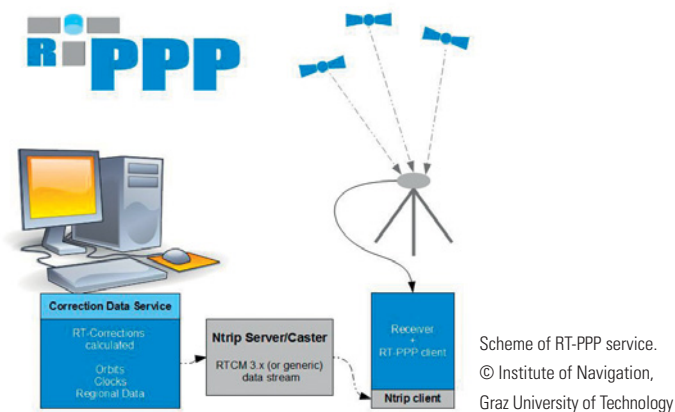

A variety of applications currently lacks a cheap though relatively precise positioning device and could highly profit from a real-time Precise Point Positioning (PPP) processing facility. PPP denotes a positioning technique where code and phase measurements from a single GNSS (Global Navigation Satellite System) receiver are used to produce precise positions using globally valid precise orbit and clock corrections provided e.g. by the International GNSS Service (IGS). Typically, an ionosphere-free linear combination is used to eliminate the ionospheric delay. Other error terms like tropospheric delay or receiver clock biases can be estimated.

Formerly the PPP technique was mainly used for post-processing due to long convergence times and a lack of precise real-time products. In the last years, however, the demand for real-time positioning with PPP has arisen together with a handful of services. Nevertheless, real-time PPP is only in the starting phase and only few applications make use of the technique. There are still many unsolved problems like the prevention of float ambiguities during PPP processing and the insufficient availability of real-time correction data directly affecting position accuracy. These problems were addressed by the RT-PPP project, whose overall goal was to develop PPP techniques suitable for various real-time or near real-time applications. The main focus was placed on the production of real-time clock, orbit and atmospheric corrections as well as their transmission via Ntrip to a user client. The options for applying integrity monitoring algorithms to PPP were also investigated. The presented approaches as well as a facility to enable reception of real-time corrections were implemented into a user module.

Extensive testing was carried out to assess the performance of the developed real-time PPP processing facility in terms of quality, integrity and availability. The project also involved assessing the suitability for real-time applications such as positioning of snow removal machines or navigation of agricultural vehicles.

### Infobox

#### Project duration:

01 January 2011 – 31 May 2012

#### Coordinator:

Graz University of Technology

Institute of Navigation

Katrin Huber

Steyrergasse 30, 8010 Graz, Austria

T: +43 (0)316 873 – 6832

[katrin.huber@tugraz.at](mailto:katrin.huber@tugraz.at)

[www.inas.tugraz.at](http://www.inas.tugraz.at)

#### Partners:

Vienna University of Technology

Institute of Geodesy and Geophysics

Robert Weber

[www.hg.tuwien.ac.at](http://www.hg.tuwien.ac.at)

TeleConsult Austria GmbH

Markus Troger

[www.teleconsult-austria.at](http://www.teleconsult-austria.at)

WIEN ENERGIE Stromnetz GmbH

Christian Klug

[www.eposa.at](http://www.eposa.at)

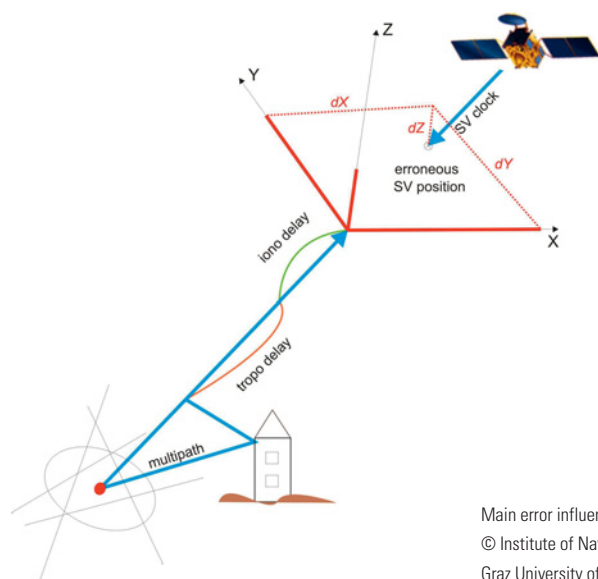

Main error influences on PPP.  
© Institute of Navigation,  
Graz University of Technology

# SoftGNSStrusted

## Signal Authentication Utilizing a Dual-frequency Software-based GNSS Receiver for Trusted Positioning

Modern Global Navigation Satellite Systems (GNSS) play a major role in various services, including critical applications in transportation, information technology, health and emergency services, defence, law enforcement, time synchronization of communication networks and many more.

However, the more valuable a resource becomes to our civil infrastructure, the more criminal or malicious agents seek to discover and exploit weaknesses in order to disrupt legitimate users or to perpetrate fraud. GNSS signals are vulnerable to intentional interference such as jamming, spoofing and meaconing.

A jamming interference is easy to detect because the position is incalculable. The detection of spoofing or meaconing intentions, however, is more difficult: the receiver does not detect the false signal because the signal appears legitimate and thus everything looks correct. Wireless connectivity, powerful laptop computers and multipurpose phones increasingly rely on their processors to handle complex radio frequency signal processing and protocol functions will make access to spoofing much easier. The need for a secure and trustworthy GNSS position will become more and more vital for many applications in our daily life. Nevertheless, no commercial GNSS receiver is currently equipped with rudimentary spoofing countermeasures. One of the basic problems is the lack of signal authentication provided via the GNSS signal.

The main goal of the SoftGNSStrusted project was to investigate new algorithms for signal authentication. The investigations were based on a previously developed software-based GNSS receiver (ASAP 6 project: SoftGNSS 2). SoftGNSStrusted involved a variety of tasks such as a thorough analysis of current and upcoming threats regarding intentional interference and their impact on the position solution. Signal specific algorithms

### Infobox

#### Project duration:

01 February 2011 – 30 April 2012

#### Coordinator:

TeleConsult Austria GmbH

Philipp Berglez

Rettenbacher Straße 22, 8044 Graz, Austria

T: +43 (0)316 890971 – 14

pberglez@tca.at

www.tca.at

#### Partners:

Graz University of Technology

Signal Processing and Speech Communication Laboratory

Klaus Witrisal

www.spsc.tugraz.at

Graz University of Technology, Institute of Navigation

Manfred Wieser

www.inas.tugraz.at

were designed to validate the signals from space. Furthermore, algorithms for authenticating the navigation data and the data transferred between a reference station and the user receiver were developed. First tests of the authentication module showed promising results so that the module is expected to prove its worth for many safety and security relevant applications in the future.

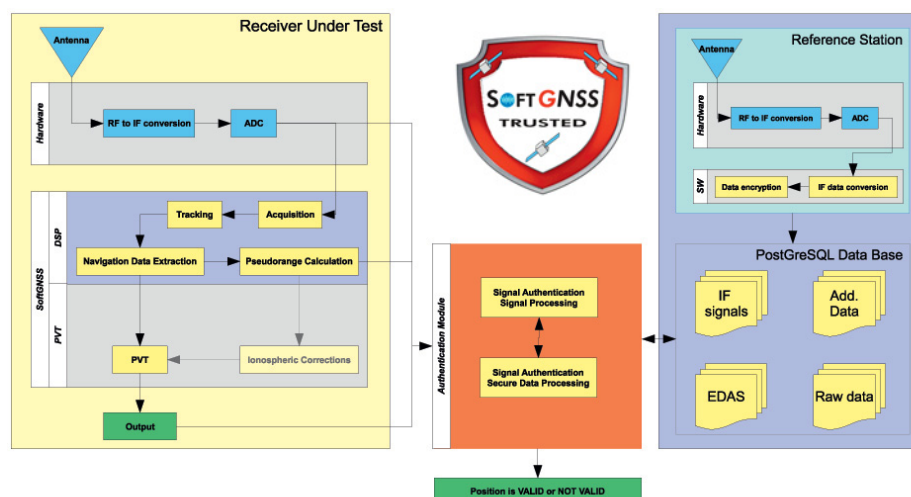

SoftGNSStrusted high-level system architecture.  
© TeleConsult Austria GmbH

# Space Science

**3D-POC**

**BRITE-Austria**

**CDSM TRL-Uplift**

**JUNO/Waves**

**MDS – MARS 500**

**METTRANS – ISS FP**

**MMS-DFG 2**

**TMIS.ascrea**

# 3D-POC

## 3D Properties of Coronal Mass Ejections

Our Sun is an active star and its most violent activity phenomena are flares and coronal mass ejections (CMEs). Flares and CMEs are closely related phenomena and can cause severe perturbations of our "space weather", i.e. the conditions in our near-Earth space environment. The effects of this solar activity are manifold and include delightful northern lights, increased radiation for manned space missions and aircraft passengers, failures in spacecraft navigation/communication systems as well as blackouts of power plants on the ground. Due to the increased need and economic dependence on space technology improving the knowledge of our space environment and forecasting our space weather are becoming ever more relevant issues.

The 3D-POC study is designed to exploit the unprecedented capabilities of the NASA Solar Terrestrial Relations Observatory (STEREO) to better understand the physical processes and propagation characteristics of solar CMEs. CMEs are the main driver of major disturbances of our "space weather". The STEREO mission consists of two Sun-orbiting spacecraft (STEREO-A and STEREO-B) with identical instrument suites observing the solar corona and heliosphere from two different vantage points. This makes it possible for the first time to reconstruct the three-dimensional (3D) geometry and 3D propagation characteristics of coronal mass ejections, which are essential in evaluating if and when a CME erupting from the Sun may hit Earth.

The 3D-POC project provides the first statistical study on the following decisive 3D properties of CMEs:

- (1) The 3D propagation parameters of CMEs (directivity, kinematics, velocity)
- (2) The "true" mass of CMEs as derived from the 3D reconstructions

The questions addressed in this study are crucially important for better understanding and modelling the propagation of CMEs from the Sun to the Earth, and thus to better forecast the CME's arrival time, velocity, and impact on our "space weather".

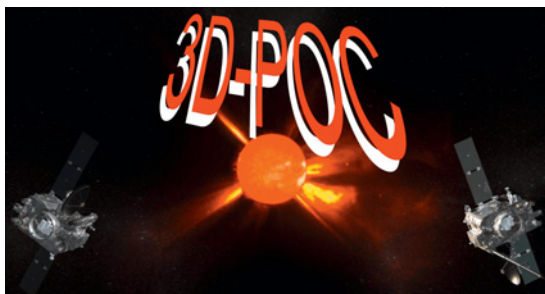

Artist's concept: STEREO-A and STEREO-B spacecraft observe the Sun from two vantage points to reveal 3D properties of dynamic eruptions. © NASA, adapted

### Infobox

#### Project duration:

01 January 2011 – 31 December 2012

#### Coordinator:

University of Graz

Institute of Physics

Manuela Temmer

Universitätsplatz 5, 8010 Graz, Austria

T: +43 (0)316 380 – 8610

manuela.temmer@uni-graz.at

www.uni-graz.at/~temmerma/

#### Partners:

Naval Research Laboratory, USA

Space Science Division

Angelos Vourlidas

www.solar.nrl.navy.mil/

University of Zagreb, Croatia – Hvar Observatory

Bojan Vrsnak

oh.geof.unizg.hr/

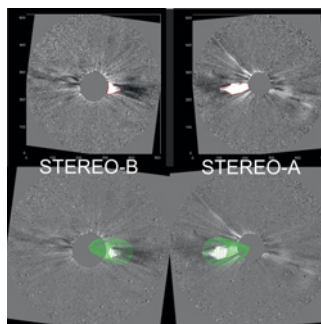

3D-POC results: CME observed from STEREO-A and STEREO-B (CME fronts are outlined in red). The direction of propagation of the CME is derived using a model (green mesh).

© 3D-POC

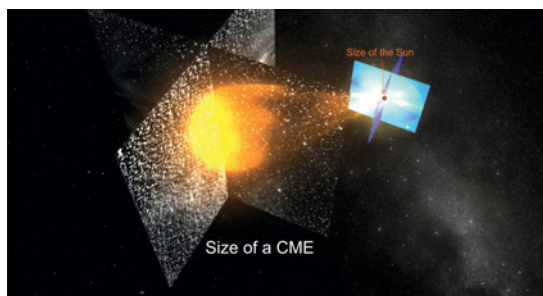

What can be derived from stereoscopic observations: 3D size of a CME in comparison to the size of the Sun. © NASA, adapted



# BRITE-Austria

## Development, Test, Launch and Operations of the Nanosatellite TUGSAT-1/BRITE-Austria for Asteroseismology

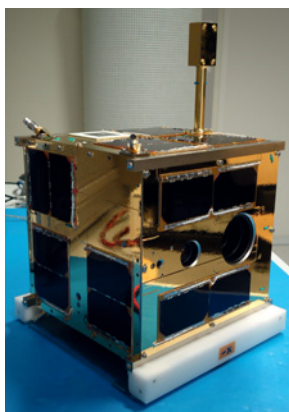

Flight Model (FM) of TUGSAT-1/BRITE-Austria. © TU Graz



Thermal vacuum testing of the assembled spacecraft. © TU Graz

In 2011 the TUGSAT-1/BRITE-Austria nanosatellite successfully completed its flight readiness review. The BRITE (BRiGht Target Explorer) mission has the scientific aim to investigate the brightness variations of massive luminous stars with unprecedented precision. Such measurements can be done from space much more efficiently, since ground-based observations would be severely handicapped by the terrestrial atmosphere. The scientific data will lead to a better understanding of the physical properties of these stars and to improved theories.

The spacecraft has a size of 20 x 20 x 20 cm and a launch mass of 7 kg. The scientific payload is a telescope with a CCD sensor operating as a differential photometer. Three miniaturized momentum wheels together with attitude sensors provide precise pointing of the spacecraft to the target stars. Power is generated by solar cells placed on all faces of the spacecraft. Three nearly-identical computers are on board: one for house-keeping and telemetry, one for autonomous attitude control and one for controlling the science payload. Commands are sent from the ground in the UHF band, whereas science data and telemetry are downlinked via the S-band transmitter of the spacecraft. An elaborate power management on board enables efficient utilization of the limited electrical power.

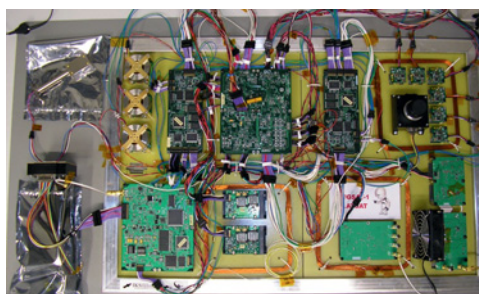

Flatsat testing: subsystems are assembled on a panel for full functional verification. © TU Graz

### Infobox

#### Project duration:

01 September 2010 – 31 July 2013

#### Coordinator:

Graz University of Technology, Institute of Communication Networks and Satellite Communications  
Otto Koudelka

Inffeldgasse 12, 8010 Graz, Austria

T: +43 (0)316 873 – 7440

koudelka@tugraz.at

www.tugsat.at

#### Partner:

University of Vienna, Department of Astrophysics  
Werner Weiss

www.brite-constellation.at

TUGSAT-1/BRITE-Austria underwent extensive environmental testing at TU Graz, including thermal shock tests of all electronic subsystems, full functional tests on the so-called "Flatsat", vibration testing of the assembled spacecraft, open-field test of the telescope and the telemetry system as well as electromagnetic compatibility verification. The most critical test was the thermal vacuum test of the whole spacecraft. TUGSAT-1/BRITE-Austria will be launched together with its sister satellite UniBRITE (ordered by the University of Vienna from UTIAS, Canada) from Southern India by the ISRO/ANTRIX Polar Satellite Launch Vehicle (PSLV), a highly reliable rocket, early in 2013. The mission control centre and ground station for TUGSAT-1/BRITE-Austria was established at TU Graz. A backup ground station was built by the Vienna University of Technology.

TUGSAT-1/BRITE-Austria will be part of the world's first nanosatellite constellation for space astronomy. Two Polish and two Canadian satellites will join the Austrian BRITEs in 2013.



Ground station antenna. © TU Graz

# CDSM TRL-Uplift

## Uplift of the Technology Readiness Level of the Coupled Dark State Magnetometer

The aim of this project was to raise the Technology Readiness Level (TRL) of a new type of scalar magnetometer called Coupled Dark State Magnetometer (CDSM). Advantages of the CDSM are the uncomplicated sensor design, the high dynamic range of more than 6 decades and the omni-directional measurement capability without additional design complexity. An absolute scalar magnetometer offers superior stability and offset-free measurements of the magnetic field magnitude. In space, it is used for improving the absolute accuracy of vector magnetometers, which also measure the direction of the magnetic field. In several cases, full science return can only be achieved by a combination of vector and scalar magnetometers. Existing scalar magnetometers are based on complex instrument designs, which have significant mass and power consumption. A miniaturized scalar magnetometer is therefore a key technology for a number of future space missions.

The CDSM is a special kind of optically pumped magnetometer. This means that the energy from a light source (e.g. laser diode) is used for exciting electrons in an atom in order to gain information about the magnitude of the surrounding magnetic field. The optical source of the CDSM is a specially modulated laser light, which excites Rubidium atoms stored in a glass cell. The measurement of the magnetic field is based on the creation of a quantum-interference effect called coherent population trapping in conjunction with the Zeeman effect in free atoms. Here, the energy shift of the atomic levels is described by the so-called Breit-Rabi formula, which only contains fundamental natural constants (such as Landé factors, Bohr magneton and Planck's constant). Therefore, the determination of magnetic fields is reduced to a frequency measurement which can be done with highest accuracy.

This project directly followed a feasibility study funded under ASAP 6. It included the development of a miniaturized Laboratory Model and an Engineering Model for the Chinese Electro-Magnetic Satellite (EMS) mission. It enabled a TRL of 5 (component validation in relevant environment) at the end of the project, which was required for the participation in a multi-sensor magnetometer proposal for the European Jupiter mission.

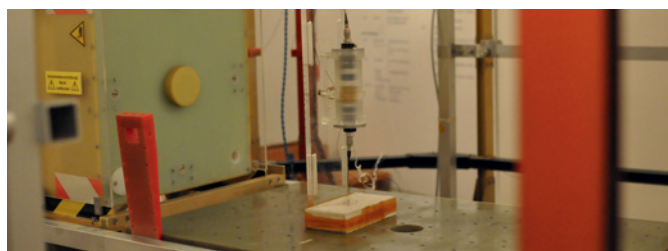

Calibration of the CDSM sensor in the Braunbek coil facility of TU Braunschweig, Germany.  
© ÖAW/IWF

### Infobox

#### Project duration:

01 September 2010 – 30 April 2012

#### Coordinator:

Austrian Academy of Sciences (ÖAW)  
Space Research Institute (IWF)  
Werner Magnes  
Schmiedlstraße 6, 8042 Graz, Austria  
T: +43 (0)316 4120 - 562  
werner.magnes@oeaw.ac.at  
www.iwf.oeaw.ac.at

#### Partner:

Graz University of Technology  
Institute of Experimental Physics  
Roland Lammegger  
iep.tugraz.at

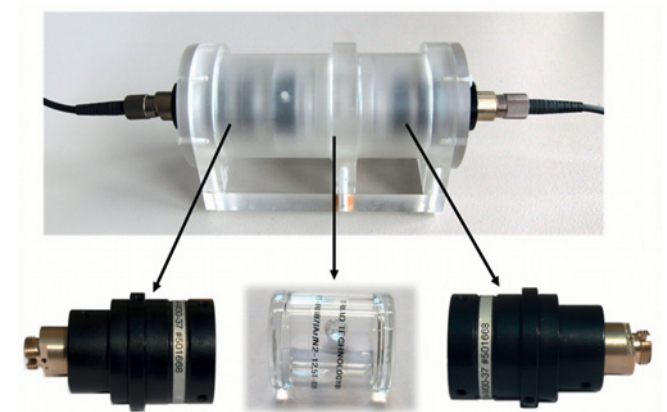

Prototype CDSM sensor with fibre couplers (bottom right and left) and a 35mm long rubidium glass cell (bottom centre). © TU Graz

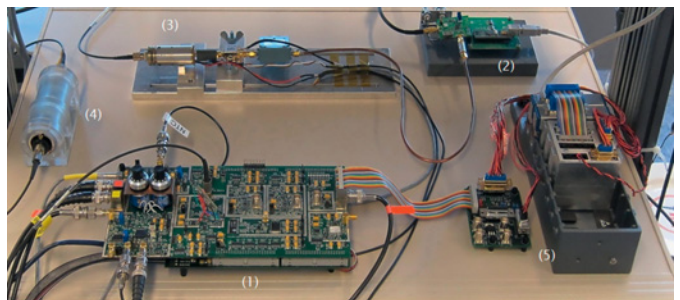

Laboratory Model of the CDSM with (1) low frequency and control electronics, (2) high frequency electronics, (3) laser module, (4) sensor and (5) ground support unit. © ÖAW/IWF

# JUNO/Waves

## Calibration of the JUNO/Waves Antenna System



Artist's impression of the JUNO spacecraft in Jupiter's orbit. © NASA

This project was dedicated to the analysis of electric field sensors as flown on board the NASA spacecraft JUNO to the gas giant Jupiter.

The overarching goal of the JUNO mission is to understand Jupiter's origin and evolution. The polar magnetosphere of Jupiter is practically uncharted territory, and the primary objective of the JUNO/Waves instrument is to explore this region, and several polar orbits should directly pass through the so-called auroral acceleration region that has never been explored. The Waves instrument utilizes a short electric dipole antenna and a body-mounted search coil magnetometer that will enable an initial reconnaissance of the plasma waves. Additionally it should identify in-situ the sources of hectometric (HOM) and decametric (DAM) radio emissions. These electromagnetic emissions are thought to be generated by the so-called cyclotron maser instability mechanism close to the gyro-frequency of magnetospheric electrons in the auroral regions of the radio planets.

In the course of the project the electric field dipole within the JUNO/Waves instrument was analysed using two different methods: experimental measurements and numerical simulations. The experimental method, called rheometry, is essentially an electrolytic tank measurement using a scale model of the spacecraft; the numerical simulations solve the underlying field equations by means of electromagnetic computer programmes. The project provides calibration information, in particular the exact antenna reception properties of the instrument and the corresponding antenna capacitances, thus improving the overall performance of the instrument.

The accuracy of the evaluation and interpretation of the electric field observations made on board the JUNO spacecraft will be significantly improved by this detailed antenna analysis.

### Infobox

#### Project duration:

01 January 2011 – 31 March 2012

#### Coordinator:

Austrian Academy of Sciences (ÖAW)

Space Research Institute (IWF)

Manfred Sampl

Schmiedlstraße 6, 8042 Graz, Austria

T: +43 (0)316 4120 – 629

manfred.sampl@oeaw.ac.at

www.iwf.oeaw.ac.at

#### Partners:

The University of Iowa

Department of Physics and Astronomy

William S. Kurth

www.uiowa.edu

Dresden University of Technology, Chair for RF Engineering

Dirk Plettemeier

www.tu-dresden.de

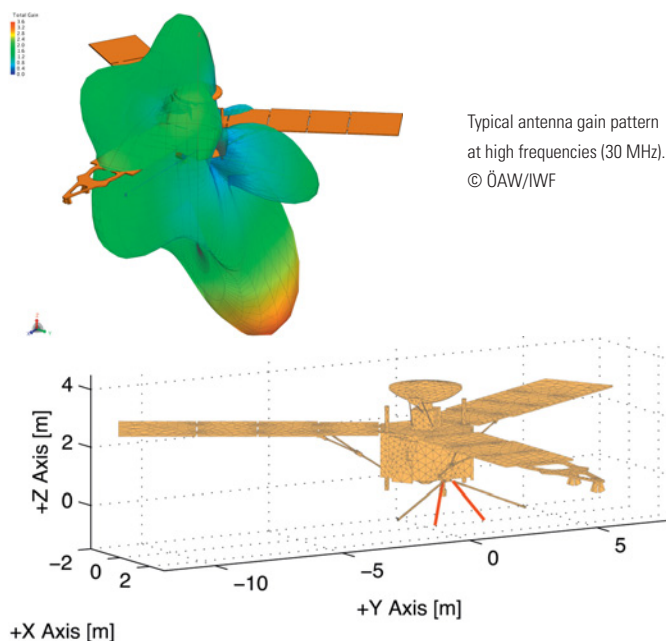

Typical antenna gain pattern at high frequencies (30 MHz). © ÖAW/IWF

Typical antenna reception properties at low frequencies (300 kHz) represented by the "effective antenna vector". © ÖAW/IWF



# MDS – MARS 500

## Multifunctional Dynamometer for Application in Space – Training and Diagnostics in the MARS 500 Project



MARS 500 container. © TU Vienna

The MDS project aims to develop a training and diagnostic device for application in space. The project is carried out by the Institute for Engineering Design and Logistics Engineering (IKL) of the Vienna University of Technology, the Centre for Sport Science and University Sports (ZSU) of the University of Vienna and the Institute of Biomedical Problems (IBMP) of the Russian Academy of Sciences.

This project was motivated by the excellent results obtained during the collaborative MOTOMIR project, which started in 1991 and the knowledge gained in these experiments. The new concept envisages a variety of different resistance exercises in combination with the rowing exercise as a training option for the cardiovascular system. The training force is produced by an electric motor and is linked to a training bar with two ropes. This concept facilitates the implementation of various training exercises, which activate many different and large muscle chains to achieve a time-saving and intensive training for the whole body. In addition to the free movement exercises, a linear and rotational guiding system is included to provide exact and repeatable diagnostics conditions to gather exact information about the physical condition of the user.

This concept was presented to the IBMP and refined for application in the MARS 500 isolation project at the IBMP in Moscow and on the International Space Station (ISS). Two prototypes of the multifunctional training device were designed and built during ASAP 5 (2007–2009). One of the prototypes was used in a 105-day test of the MARS 500 isolation project. The results of this test were considered in the redesign of the MDS. An updated version of the MDS was integrated and used in the 520-day isolation experiment of MARS 500 during ASAP 7. A 6-member crew was isolated for 520 days in an environment simulating a flight to Mars, during which the crew members performed training sessions and diagnostic tests on the MDS.

### Infobox

#### Project duration:

01 May 2010 – 31 December 2012

#### Coordinator:

Vienna University of Technology

Institute for Engineering Design and Logistics Engineering

Thomas Angeli

Getreidemarkt 9/307-3, 1060 Vienna, Austria

T: +43 (0)1 58801 – 30620

thomas.angeli@tuwien.ac.at

www.ikl.tuwien.ac.at

#### Partner:

University of Vienna

Centre for Sport Science and University Sports

Norbert Bachl

zsu-schmelz.univie.ac.at

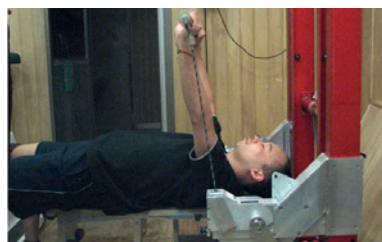

Bench press in MARS 500.

© IMBP

Examples of exercises on the MDS.

© TU Vienna

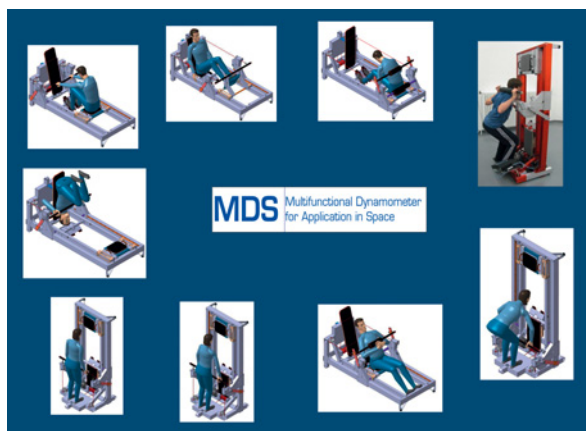

The data were analysed and support was provided if necessary. After the successful completion of the 520-day test the partners from the IBMP once more expressed their interest in the use of the MDS on the ISS.

# METTRANS – ISS FP

## Metastable Solidification of Novel Peritectic Structures – Studies With Transparent Model Alloys: ISS Flight Preparation

Many commercial metals such as steels, bronze and various copper alloys show a peritectic reaction during solidification, meaning that the solid forming during freezing of the melt suddenly changes from an alpha- to a beta-type crystal. Although economically of great importance this phenomenon is still little understood, especially when it comes to optimization of product quality by microstructure adjustment. Detailed investigations on Earth are disturbed by natural convection, which is always present during cooling of a melt. The METCOMP team from the European Space Agency (ESA) thus intends to perform specific microgravity experiments on sounding rockets and on the International Space Station (ISS) where natural convection is mostly suppressed.

One of these experiments will use a transparent analogue material which solidifies like a metallic alloy but allows the observation of the solidification dynamics and phenomena occurring at the solid/liquid interface. This material will be processed on the ISS within the TRANSPARENT ALLOYS instrument developed by ESA. This instrument will serve as a highly specified tool for long-term investigations on transparent model materials under reduced gravity conditions on the ISS. Presently ground based laboratory investigations are in progress in order to calibrate the new instrument and thus define the process window for the upcoming experiments on ISS.

The METTRANS–ISS FP project is especially dedicated to in-situ observations of morphological changes occurring near the peritectic temperature. Various peritectic growth modes have already been identified, such as two-phase array growth of alpha and beta cells/dendrites, second-phase nucleation ahead of the primary front and subsequent island growth or formation of lateral layered structures and the celebrated isothermal couple peritectic growth. The quantitative determination of the corresponding process window for all these phenomena is ongoing.

The main partners of the associated ESA MAP (Microgravity Application Programme) project METCOMP are:

- > Matthias Kolbe, German Aerospace Center (DLR), Germany
- > Michel Rappaz, École Polytechnique Fédérale de Lausanne (EPFL), Switzerland

### Infobox

#### Project duration:

01 November 2011 – 31 October 2012

#### Coordinator:

Montanuniversität Leoben

Chair for Simulation and Modelling of Metallurgical Processes

Andreas Ludwig

Franz-Josef-Straße 18, 8700 Leoben, Austria

T: +43 (0)3842 402 – 3101

[smmp@unileoben.ac.at](mailto:smmp@unileoben.ac.at)

[www.smmp.at/hm](http://www.smmp.at/hm)

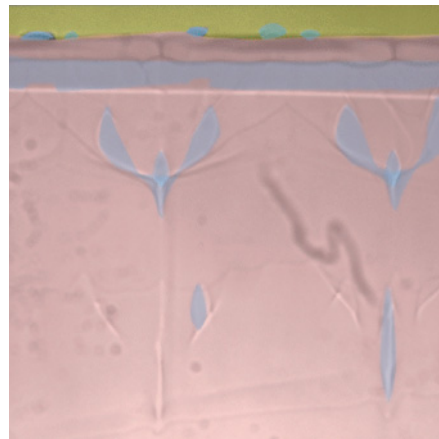

Two-phase growth of a near peritectic model alloy.

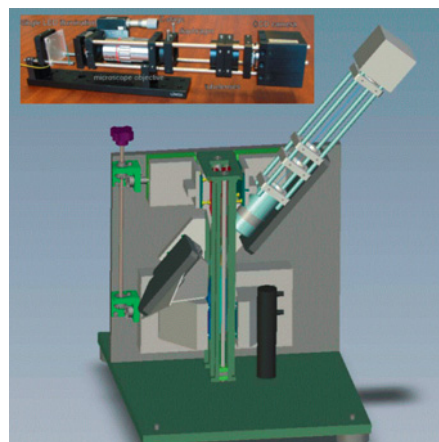

Optical and thermal breadboard of the TRANSPARENT ALLOYS instrument.

# MMS-DFG 2

## Flight Model Development of the Digital Fluxgate Magnetometer for NASA's MMS Mission

NASA's Magnetospheric MultiScale (MMS) mission will explore the dynamics of the Earth's magnetosphere and its underlying energy transfer processes. Four identically equipped spacecraft are to carry out three-dimensional measurements in the Earth's magnetosphere. The launch of the four spacecraft is scheduled for October 2014.

The Space Research Institute (IWF) of the Austrian Academy of Sciences was invited to participate in the development of the dual fluxgate magnetometer for NASA's MMS mission by supplying an especially miniaturized front-end electronics for the Digital FluxGate (DFG) magnetometer. DFG is part of a larger instrument suite called FIELDS, which is led by the University of New Hampshire. The sensor for DFG is supplied by the University of California, Los Angeles.

The core component of the electronics is an Application Specific Integrated Circuit (ASIC) which has been developed by IWF jointly with the Fraunhofer Institute for Integrated Circuits. It is called Magnetometer Front-end ASIC (MFA) and was manufactured by austriamicrosystems (ams). The mixed-signal (analogue and digital) MFA, which is assembled in a 100-pin wide space qualified package, reduces the required power for the readout electronics by a factor of 10 and more as well as the area needed on a printed circuit board by a factor of 3 to 4 compared to magnetic field instruments, e.g. on board Venus Express (ESA) and THEMIS (NASA).

This project directly followed the ASAP 5 DFG-MFA project, which included the manufacturing and space qualification of the MFA as well as the development of an Interface Verification Model and an Engineering Model of the DFG electronics. The ASAP 7 MMS-DFG 2 project covered the assembly, calibration and integration of a total of four Flight Models and one Spare Model. Calibration showed that the flight models fully met all performance requirements. The intrinsic noise of the magnetometer at 1 Hz is 5 pT/sqrt(Hz) and thus a factor of two lower than required for the MMS mission.

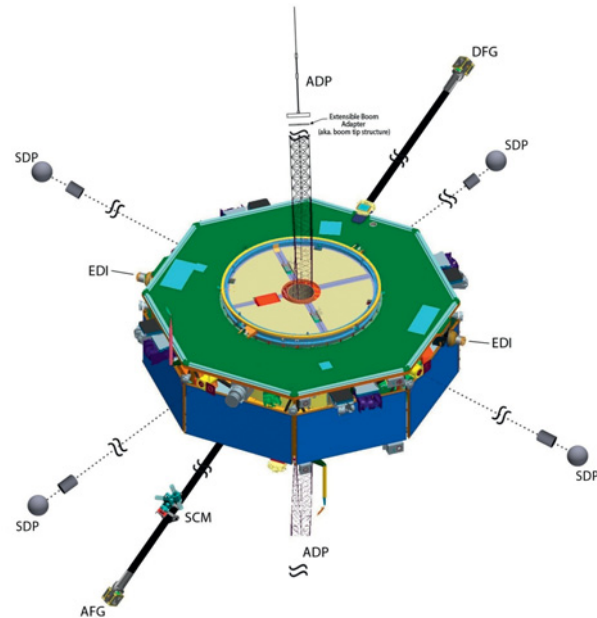

FIELDS instrument suite schematics with DFG sensor on magnetometer boom.  
© University of New Hampshire

### Infobox

#### Project duration:

01 August 2010 – 31 July 2013

#### Coordinator:

Austrian Academy of Sciences (ÖAW)  
Space Research Institute (IWF)  
Werner Magnes  
Schmiedlstraße 6, 8042 Graz, Austria  
T: +43 (0)316 4120 – 562  
werner.magnes@oeaw.ac.at  
www.iwf.oeaw.ac.at

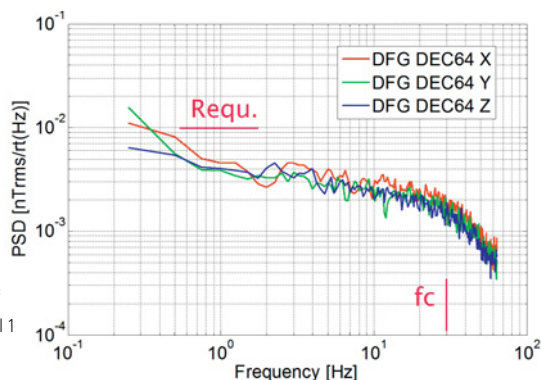

Noise density plot of the DFG Flight Model 1 sensor components.  
© ÖAW/IWF



Flight Model of DFG electronics with Magnetometer Front-end ASIC in the middle (chip with golden lid). © ÖAW/IWF

## Automatic Selection, Categorization and Recognition of Areomorphic Features

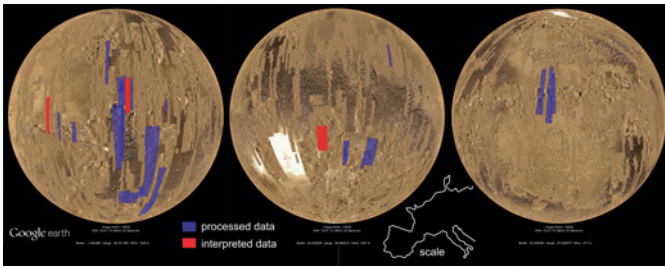

Coverage of processed and interpreted image data presented on Google Mars.

One of the most successful planetological exploration missions is ESA's Mars Express. The probe reached Mars in December 2003 and has been delivering a host of valuable data since then. The High Resolution Stereo Camera (HRSC) played a central role in this project. The captured images provided the basis for deriving a highly accurate three-dimensional Digital Terrain Model (DTM) of the planet. The project focused on an automated areomorphic (i.e. Mars-related morphological) analysis based on DTM data. Automation has become inevitable due to the large amount of available data.

On Mars, the presence of impact craters of various sizes, large shield volcanoes, and the surface processes dominated by aeolian and mass wasting processes result in a very interesting surface pattern. Unlike on Earth, fluvial processes make no contribution, although they might have in an earlier evolution phase. A high percentage of slopes are covered by detrital material like colluvium or talus; consequently, slope angles on Mars are typically less steep than on Earth, and the distribution of slopes is characteristic of the actual landscape.

The developed DTM segmentation procedure, an error-tolerant, robust planar feature extraction method, aimed at deciphering this property. The presence of planar facets is assumed to disclose information about the forming geological or geomorphic processes. The method was tailored to various geoscientific applications. Parallel computation and sophisticated techniques were used for data storage and processing in order to cope with the huge amount of data and to achieve good performance. Processing of whole DTMs along an orbit became feasible.

The process resulted in thousands of planar faces which needed further analysis. Input parameters can be used to control the accuracy and adjust the analysis to cover diverse features like impact craters, volcanoes, scarps, debris slopes and landslides. This sort of analysis provides valuable information to geologists and enables them to gain a deeper understanding of Martian surface processes.

### Infobox

#### Project duration:

01 January 2011 – 30 June 2012

#### Coordinator:

Vienna University of Technology  
Department of Geodesy and Geoinformation

Josef Jansa

Gußhausstraße 27-29/120, 1040 Vienna, Austria

T: +43 (0)1 58801 – 12236

Josef.jansa@tuwien.ac.at

www.ipf.tuwien.ac.at

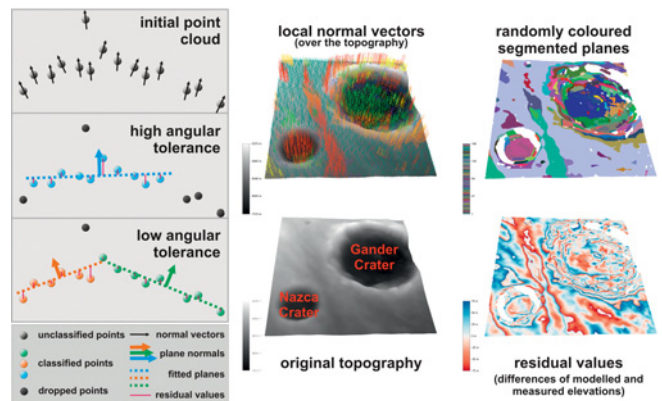

Principle of segmentation algorithm (left) and sequence of processing steps (right, clockwise from original topography).

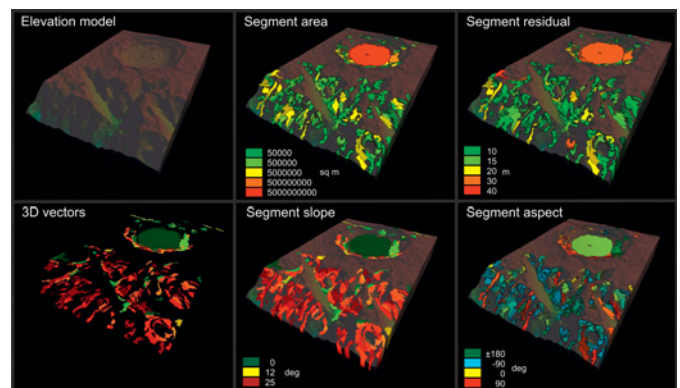

Various surface properties as a result of segmentation.

# Space Technology

**ACTRESS**

**ADAM**

**ASOT**

**BII-NACO**

**DIACERAM**

**FRESSCO**

**FRPBonding**

**ISS-SLEEP-KIT**

**NEMO**



# ACTRESS

## Advanced Composite Technologies for Extreme Lightweight Space Structures



Flight unit SYLDA version C.  
Courtesy Astrium ST

The objectives of the ACTRESS project funded by the Austrian Research Promotion Agency under ASAP 7 were to initiate a long-term sustainable programme in Austria for the design, analysis and manufacture of extremely lightweight structures on the basis of advanced nano-modified composite materials, especially carbon fibre-reinforced carbon nanotube-filled thermoset polymer composite materials. ACTRESS should not only be understood as a starter project for a subsequent material development programme. The activities aim to establish the whole process chain for the production of extreme lightweight structures for aerospace application in Austria.

ACTRESS was structured into three work areas specifically formulated with respect to the experiences and abilities of the individual project partners:

Graz University of Technology/Institute for Lightweight Design (TUG/ILB) worked on the development and validation of an analytical model based on laminate theory for the design and layout of lightweight structures of advanced nano-modified composite materials. A special focus was placed on the formulation of material laws for modelling the beneficial effects of nanofillers for improvement of the mechanical properties of the new composite materials.

Mubea Carbo Tech GmbH, Salzburg (MCT) concentrated on adapting proven production processes for novel, nano-modified composite materials. Samples of these materials were produced by MCT and the effect of nanofillers on the mechanical properties (significant improvement of interlaminar shear strength, toughness and fatigue) was demonstrated by tests at TUG/ILB.

### Infobox

#### Project duration:

01 October 2010 –29 February 2012

#### Coordinator:

Space Technology Consultancy Vienna  
Hans Georg Wulz  
Kroissberggasse 27, 1230 Vienna, Austria  
T: +43 (0)1 8900625  
info@rtbv.at  
www.rtbv.at

#### Partners:

Mubea Carbo Tech GmbH  
Johannes Renner  
www.carbotech.at

Graz University of Technology  
Institute for Lightweight Design  
Christian Moser  
www.leichtbau.tugraz.at

Material Property	Unit	Improvement by Adding CNTs
Epoxy LY 556		
$\sigma$ (ILSS, Compression Strenght)	MPa	> 50%
Fatigue, Lifetime	10 <sup>6</sup> cycles @ load profile	> 250%
E (Lightweight, Harm. Oscillations)	GPa	0 (unaffected good)
CTE (Thermal Strain $\rightarrow$ Zero)	ppm/K	0 (unaffected good)
TC (Thermal Conductivity)	W/mK	~ 10 %
$\alpha / \varepsilon$ (Absorption/Emission)		~ 10 %
G1C (Toughness)	MPa*m <sup>1/2</sup>	> 30%
CME (Moisture Strain)	m/m %H2O	0
EC (Electrical Conductivity)	S/m	~ 10 %
Shrinkage, Accuracy of Product	%	~ 20 %

Carbon fibre reinforced epoxy composite, improvement of properties by dispersion of 0.5 w% carbon nanotubes. © RTBV

Space Technology Consultancy Vienna (RTBV) was responsible for project coordination and the definition of new advanced material systems. Nano-modified resins were delivered by FutureCarbon GmbH, Bayreuth, Germany.

The successful completion of ACTRESS has opened up the opportunity to become a supplier of structural components in European Future Launcher Programmes, such as the "New Generation Launcher Programme" in close collaboration with Astrium Space Transportation.

# ADAM

## Analytical Nonlinear Damper Modelling

RUAG Space GmbH (RSA) develops and uses non-linear damping systems for space applications in order to protect sensitive items like spacecraft ion thrusters or spacecraft electronics from mechanical impacts during lift-off or prevent mechanical damage to spacecraft during transport.

Standard linear analysis methods cannot be applied for the analytical prediction of the behaviour of non-linear damped structures. The ADAM project was aimed at investigating the case that both the damping rate and the spring rate are non-linear and a function of the deflection, and that the damping rates and eigenfrequencies of the damper and the adjacent structure are different. This involved the development of a transient, non-linear finite element analysis model and correlation with a non-linear test specimen, a cable shock damper presenting highly non-linear behaviour.

Such an analysis model can be applied to viscous damped deployments (e.g. to the RSA viscous dampers), elastomer damped units (e.g. RSA thruster pointing mechanisms) or cable shock damped units (e.g. RSA spacecraft transport units) and will help to minimize design loops or even tests.

### **Infobox**

#### **Project duration:**

02 November 2010 – 30 September 2012

#### **Coordinator:**

RUAG Space GmbH

Thomas Kessler

Stachegasse 16, 1120 Vienna, Austria

T: +43 (0)1 80199 – 2990

[thomas.kessler@ruag.com](mailto:thomas.kessler@ruag.com)

[www.ruag.com/space](http://www.ruag.com/space)

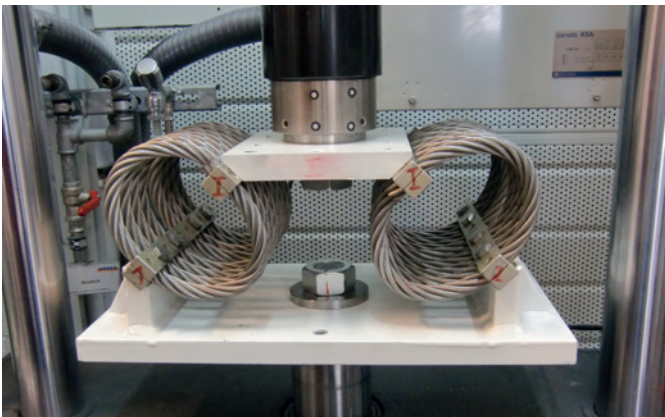

Cable shock damper test set-up. © RUAG Space GmbH

# ASOT

## Application-specific Surface Structuring of Thermal Insulation



MetOp satellite. © ESA

The ASOT project focuses on the development of a range of thermal vacuum insulation materials for spacecraft and other high technology applications. By appropriate surface patterning the material properties can be tailored to fit the requirements of the intended use.

The project involves the tuning of several different material properties with a focus on electrical (surface) conductivity of coated films with variable functionality. The methods used for achieving the desired surface properties range from (vacuum deposition) coating, printing and chemical etching to mechanical processing.

Another important goal is the minimization of mass: Advanced printing processes were investigated for the coating and reinforcement of thermal insulation foils. The polymer grids carry the loads while the thin foil is suspended in between.

The ASOT research project has led to the development of a range of high performance insulation materials and corresponding production processes for use in spacecraft and other high technologies and the production of first prototypes together with partners and potential customers. The transfer of space technology to terrestrial applications will enable the development of products that represent a great improvement over the current state-of-the-art products in markets such as cryogenic industries and electrical power engineering.



### Infobox

#### Project duration:

01 February 2011 – 31 July 2013

#### Coordinator:

RUAG Space GmbH

Erhard Prechelmacher

Stachegasse 16, 1120 Vienna, Austria

T: +43 (0)1 80199 – 2310

Erhard.Prechelmacher@ruag.com

[www.ruag.com/thermal](http://www.ruag.com/thermal)

#### Partners:

Vienna University of Technology, Institute of  
Electrodynamics, Microwave and Circuit Engineering  
Peter Schönhuber

[www.emce.tuwien.ac.at/](http://www.emce.tuwien.ac.at/)

Vienna University of Technology, Institute of Materials  
Science and Technology

Jürgen Stampfl

[www.tuwien.ac.at](http://www.tuwien.ac.at)

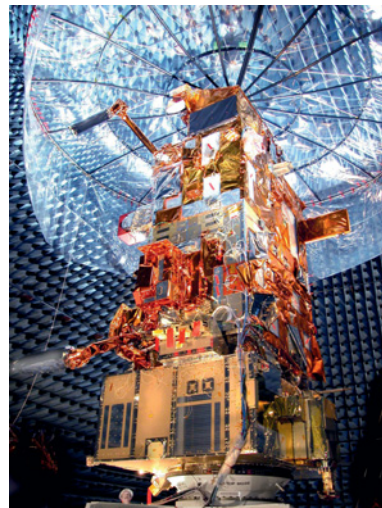

MetOp spacecraft during testing.  
© ESA

Super-insulation for cryogenic applications.  
© RUAG Space GmbH

## Bio-inspired Ultra Lightweight Nanocomposite Materials for Application to Large and Gossamer Structures in Space

The main objective of BII-NACO was the development of lightweight bio-inspired nanocomposite materials with advanced nanostructural features and their evaluation for space applications. The aim was to test such "second generation nanocomposites" for their potential to achieve desired mechanical properties simultaneously (e.g. strength and elasticity) and to use nano-scale matrix modification to solve existing issues in composites for space applications, such as matrix-fibre delamination.

Special emphasis was put on binary and ternary systems combining different nanofillers forming dedicated substructures in the host matrix. It had been observed previously that introduction of more than one nano-species may lead to synergistic effects, i.e. more than additive improvement of material properties. Moreover, spatial arrangement and orientation of nano-species are known to be crucial factors in determining overall material properties, but are typically poorly controlled.

In biology, by contrast, strong and lightweight materials generally exhibit exquisite structural control on the nanometre scale. Some of them still surpass the mechanical performance of technical materials weight by weight. Therefore, bio-inspired construction principles were extracted by review and used for the modification of existing materials based on space relevant polymer matrix systems. Technical approaches included the combination and chemical modification of nano-species and measures of structural control. The project consortium combined interdisciplinary expertise in space technology, physics, chemistry, materials science and biology to develop such novel materials for large and gossamer structures.



### Infobox

#### Project duration:

01 June 2012 – 31 May 2014

#### Coordinator:

University of Natural Resources and Life Sciences

Institute of Physics and Materials Science

Helga Lichtenegger

Peter-Jordan-Straße 82, 1190 Vienna, Austria

T: +43 (0)1 47654 – 5152

helga.lichtenegger@boku.ac.at

www.map.boku.ac.at/physik.html

#### Partners

Medical University of Vienna

Decentralized Biomedical Facilities

Ursula Windberger

www.meduniwien.ac.at

Aerospace & Advanced Composites GmbH

Josef Wendrinsky

www.aac-research.at

Space Technology Consultancy Vienna

Hans Georg Wulz

www.rtbv.at



Wood as an example of a natural lightweight nanocomposite for large structures. It exhibits a hierarchical architecture and sophisticated structure on the nanometre scale. © BOKU Vienna

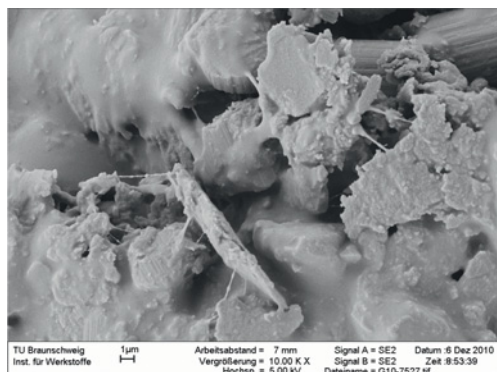

SEM micrograph of a fracture surface of carbon fibre reinforced epoxy sample with 0.5 w% finely dispersed carbon nanotubes, view 1.

Courtesy DLR Braunschweig

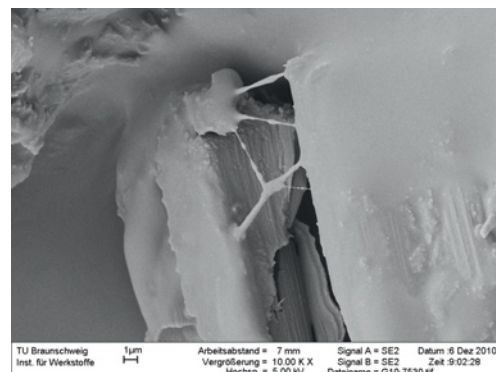

SEM micrograph of a fracture surface of carbon fibre reinforced epoxy sample with 0.5 w% finely dispersed carbon nanotubes, view 2.

Courtesy DLR Braunschweig

# DIACERAM

## High Thermal Conductive Ceramic-Diamond Substrates for Efficient Cooling of Next Generation of High Performance Space Electronics



Synthetic diamond particles and coated diamond particles used as raw materials for ceramic-diamond composites.



Induction heated hot pressing device used for the consolidation of ceramic-diamond composites. Both Pics © RHP-Technology/h.steiner/derfisch.at

The DIACERAM project focuses on the development of a next generation ceramic substrate material for application in electronic components. In many electronic applications ceramic substrate materials are needed in order to provide electrical insulation. At the same time the semiconductor chips are mounted on these substrates. Due to the generally higher increase of power density in electronic components there is a strong need for ceramic materials which are characterized by high thermal conductivity and a low coefficient of thermal expansion in order to allow reliable and sufficient cooling of the semiconductor chip. Today's ceramic materials have thermal conductivities in the range of up to 200-260 W/mK.

The main goal of this project is to develop high thermal conductive substrate materials (>400 W/mK) by introducing synthetic diamond particles as a filler in a ceramic matrix. Diamond is the best thermal conducting material (1000-2000 W/mK), but there are many challenges in using it as a filler material.

A systematic analysis of thermal transport properties in a ceramic-diamond combination provides the basis for selecting the most promising candidate ceramic matrix materials for further material development.

Reducing the processing temperature is essential when working with ceramics in combination with diamonds. This will be achieved by modification of the ceramic matrix (using additives) in order to protect the diamond from decomposition/graphitization when exposed to high temperature. In addition, a rapid processing technology will be used for the consolidation (direct hot pressing) to be able to apply high heating rates of several 100K/min in combination with short cycle times. The diamonds will additionally be coated with appropriate surface/protective layers in order to provide good compatibility with the ceramic matrix material and protect the diamond.

### Infobox

#### Project duration:

01 January 2012 – 31 December 2013

#### Coordinator:

RHP-Technology GmbH & Co. KG

Erich Neubauer

Forschungszentrum, 2444 Seibersdorf, Austria

T: +43 (0)2255 20600 – 10

[erich.neubauer@rhp-technology.com](mailto:erich.neubauer@rhp-technology.com)

[www.rhp-technology.com](http://www.rhp-technology.com)



The developed materials are systematically analysed with respect to their thermal, mechanical and electrical properties. Application areas for such types of ceramic materials are to be found in various electronic modules (power packages, multichip packages, radiofrequency/microwave packages, hermetic packages etc.) used in telecommunication.

Material	Thermal Conductivity [W/mK]	Coefficient of Thermal Expansion [ppm/K]	Comment
Al <sub>2</sub> O <sub>3</sub>	~20	7 – 8	most cost efficient material
Si <sub>3</sub> N <sub>4</sub>	60 – 80	3 - 4	expensive, limits in thermal conductivity
AlN	180 -200 (230)	4 – 5	low CTE, good TC
BeO	~ 260	8 - 9	High thermal conductivity, medium CTE, => TOXIC!
Diamond	1.000 – 2.000	~1	only in small size; CVD diamond is expensive
Next generation "DIACERAM"	300 – 400+	4 – 8	in development

Material properties of state-of-the-art ceramics and new DIACERAM material. © RHP-Technology

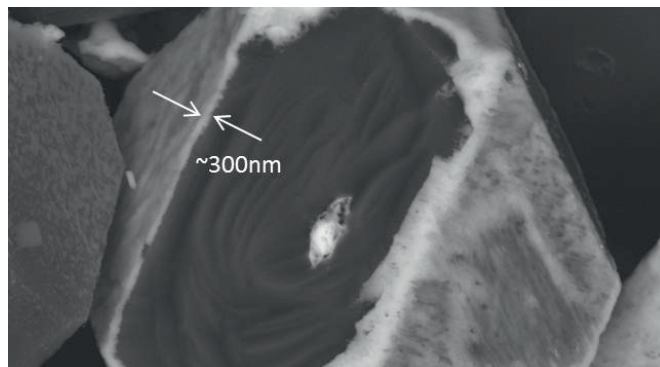

Image of a coated diamond particle (obtained by scanning electron microscope).

© RHP-Technology

# FRESSCO

## Searching the Link Between Fretting Tests and Shaker Tests for Cold Welding

Spacecraft subsystems contain a variety of engineering mechanisms that exhibit many surface contacts, which may be periodically closed up to several thousand times during ground testing and the operational life of the spacecraft. These contacts are usually designed to be static, but in reality they are often subjected to impact forces.

The project covers a detailed investigation of fretting phenomena during launch. The main challenge is to simulate conditions expected during the launch of a satellite: one part (one material) is subjected to very high acceleration and frequency while a second moves "freely" on it. Furthermore, the project will cover a review of requirements for testing, design, set-up and verification.

A main innovation step is the possibility to offer component testing under real launch conditions, which would avoid potential misinterpretations occurring in accelerated testing. This would represent a further step in the development of these components and enhance the reliability of validation.

### Infobox

#### Project duration:

01 December 2010 – 31 October 2012

#### Coordinator:

Aerospace & Advanced Composites GmbH

Materials & Components Test House

Markus Fink

Viktor Kaplan-Straße 2, 2700 Wiener Neustadt, Austria

T: +43 (0)2622 90550 – 430

markus.fink@aac-research.at

www.aac-research.at

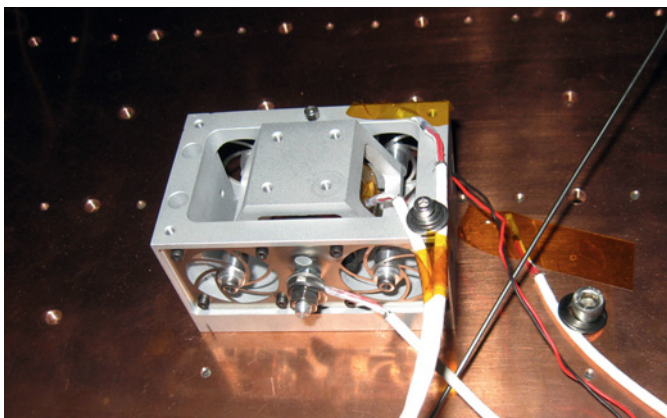

Shaker in vacuum chamber with thermocouples (white wires, for measurement of self-heating during work under vacuum).

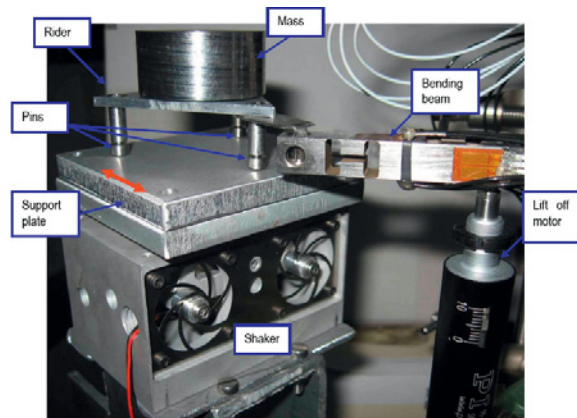

First prototype (shaker and measuring unit) mounted in vacuum chamber for first tests.

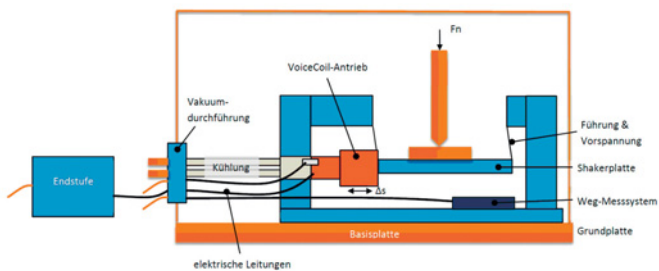

Basic design of FRESSCO (after successful tests with first prototype).

# FRPBonding

## Bonding Technologies for Fibre Reinforced Plastic

Transportation and storage containers for cryogenic fluids like liquid helium (LHe), liquid oxygen (LOx) and liquid hydrogen (LH2) used in space applications down to 4.2 K (= -269°C) are commonly made of austenitic steels and aluminium alloys. The main focus in future developments is on mass reduction. Composite components have a high potential in this respect, especially when exposed to extreme environmental conditions.

MAGNA STEYR is a manufacturer of stainless steel cryogenic propellant feed lines for Ariane 5. Since 2009 MAGNA STEYR has been working on the next generation of feed lines for cryogenic propellants made of fibre reinforced composites under ESA's FLPP (Future Launchers Preparatory Programme).

The basic design is a stainless steel liner which supports the filament winding process and acts as a permeation barrier for the media inside. In the filament winding process, the liner is wound with glass fibre and carbon fibre tapes and cured in an autoclave. The inner steel liner is afterwards electrochemically milled to produce a lightweight thin-walled structure.

Feed lines are exposed to high thermal stresses during operation, e.g. when cryogenic propellants are pumped through during the start sequence. The different thermal expansion and contraction behaviour of steel and composite material may cause the liner to separate from the composite structure.

The goal of this project was to identify the best adhesive to avoid disbonding between metal and fibre reinforced plastic.

This required the following tasks to be dealt with:

- > Definition of the requirements
- > Material pre-selection
- > Development of mechanical/chemical pre-treatment processes for pre-selected adhesives
- > Evaluation of surface cleaning and additional surface activation processes
- > Evaluation of the developed process in both 2D and 3D applications

The selected processes will be applied in a variety of space projects.

The partner Aerospace and Advanced Composites contributed its materials expertise for producing test samples and testing at cryogenic temperatures.

### Infobox

#### Project duration:

01 June 2011 – 31 May 2013

#### Coordinators:

MAGNA STEYR Fahrzeugtechnik AG & Co KG

Karl Ebner

Liebenauer Hauptstraße 317, 8041 Graz, Austria

T: +43 (0)664 8840 8034

karl-hans.ebner@magnasteyr.com

www.magnasteyr.com

#### Partner:

Aerospace & Advanced Composites GmbH

Michael Scheerer

www.aac-research.at

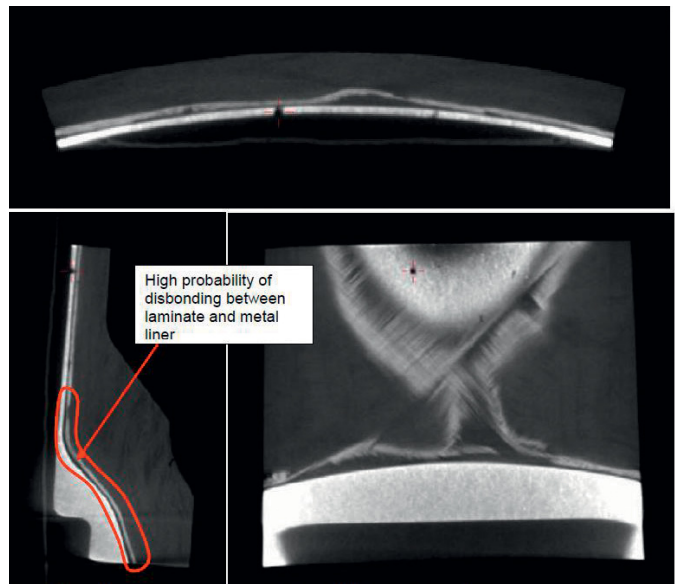

Disbonding between steel liner and fibre reinforced plastic if no adhesives are used.

© MAGNA STEYR, Aerospace and Advanced Composites

# ISS-SLEEP-KIT

## Sleeping Bag for the International Space Station



ISS-SLEEP-KIT: application of astronaut sleeping bag on board ISS (collage).  
© Bruno Stubenrauch/background image courtesy of NASA

### Infobox

#### Project Duration:

01 October 2010 – 30 June 2011

#### Coordinator:

LIQUIFER Systems Group GmbH  
Barbara Imhof, Waltraut Hoheneder  
Obere Donaustraße 97/1/62, 1020 Vienna, Austria  
T: +43 (0)1 21885 – 05  
desk@liquifer.com  
www.liquifer.com

The aim was to investigate the feasibility of designing and testing a sleeping bag for ISS. The methodology used included the fabrication of a prototype from material used on ISS such as Nomex-based textiles. The development of the sleeping bag involved a total of three design iterations based on feedback from European astronauts.

Current research in the area of medicine and psychology supports this study regarding near-term measures to be taken to improve the quality of sleep and to mitigate fatigue. Fatigue is a significant problem faced by astronauts, leading to reductions in alertness and performance and eventually to errors and mishaps. Non-pharmacological methods may be used to alleviate symptoms of fatigue, taking into consideration that difficulties may arise in sleep initiation and maintenance, such as poor sleep hygiene or circadian dyssynchrony. There are very few resources focused on the significance of fatigue in operational settings and the

mitigation of sleep debt. There is a need for continued attempts to evaluate sleep and ensure proper work-rest scheduling in human missions.

The team prepared relevant documentation for ESA to fly and test the sleeping bag. The last missing steps in testing the current design on ISS are the material tests and the inclusion into a mission.

The feasibility analysis showed that it is viable to make a step into a life science experiment in broadening the scope of the project with a solid medical character because there is a need to optimize the health and safety of astronauts before, during, and after space travel. The knowledge acquired in understanding the effects of spaceflight on human physiology and the practice of medicine in extreme environments will also play an important role in furthering health care on Earth.



ISS-SLEEP-KIT: 3D-rendering of astronaut sleeping bag. © LIQUIFER Systems Group/rendering: Kjell Herrmann

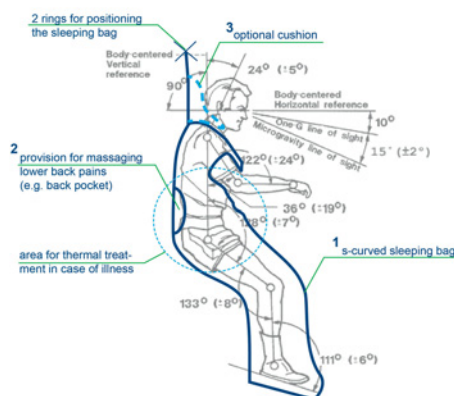

ISS-SLEEP-KIT: systems diagram of astronaut sleeping bag. © LIQUIFER Systems Group/background sketch courtesy of NASA



ISS-SLEEP-KIT: prototype of astronaut sleeping bag. © Bruno Stubenrauch



# NEMO

## Neodymium Iron Motor

The NEMO project aimed at investigating the suitability of a new type of Neodymium Iron Boron (NdFeB) magnet for space application and the issues to be addressed in this context. Since small electric motors conventionally use permanent magnets as rotors, their material properties have a huge impact on motor performance.

An electric motor making use of state-of-the-art Samarium Cobalt (SmCo) magnets was used as a simple demonstrator. The rotor of this electric motor was designed for the new type of NdFeB magnets. A comparison was made based on detailed analysis loops and tests. The permanent magnets were assembled into the rotor of the demonstrator, one equipped with SmCo magnets (for benchmarking purposes) and the other with the new type of NdFeB magnets. Finally, the test results were compared with typical space requirements.



Electric motor demonstrator. © RUAG Space GmbH

### **Infobox**

#### **Project Duration:**

01 March 2012 – 28 February 2013

#### **Coordinator:**

RUAG Space GmbH

Thomas Kessler

Stachegasse 16, 1120 Vienna, Austria

T: +43 (0)1 80199 – 2990

[thomas.kessler@ruag.com](mailto:thomas.kessler@ruag.com)

[www.ruag.com/space](http://www.ruag.com/space)



# Telecommunications

**ASLE**

**CDPP**

**COSA**

**GeMIE**

**NextNav**

**ONE-SAT-ILS**

**QTS**

**SGIS**

**TCTM**

**TM/TC Modem**

Satellite emulators currently on the market target the Ka, Ku and lower band systems, where most commercial applications occur. These products cover the typical satellite link characteristics such as delay, Doppler, attenuation, AWGN and frequency errors. These parameters can be controlled by the emulators in a dynamic as well as in a static way in order to generate a realistic link model.

The Q/V band (30 to 50 GHz), the next area for commercial exploration, poses certain challenges for communication equipment. In this band, scintillations and strong attenuation dynamics require the modem designers to have appropriate algorithms in place to counteract channel impairments.

It is not feasible to use traditional counter measurements like high amplifier back off and high fade margins for these effects when the satellite system is to be operated in a cost effective way. The modern approach is to use algorithms in the digital domain which compensate for these distortions, and this is where the Q/V band link emulator plays a crucial role.

The algorithms must be verified for performance and stability specifications. One approach is to use the real channel although this has the following drawbacks:

- > Few Q/V band transponders are currently available
- > Difficulty in exactly repeating a test with fading situations (of crucial importance in the development phase)
- > Rental costs of the transponder can be high
- > Risk of imperfect spectral transmission at the prototype level, which is not desirable on a commercial satellite

The above points are compensated by a satellite link emulator. Hence the advantages of Q/V band link emulators are as follows:

- > Cost-effective emulation of effects in the Q/V satellite band
- > Repeatable results
- > Realistic impairments
- > System optimization due to minimum margins
- > Stochastic models for the channel, based on ITU-R recommendations, can be emulated
- > Location independent design and test (no antenna and satellite necessary, IF band = 70 MHz)

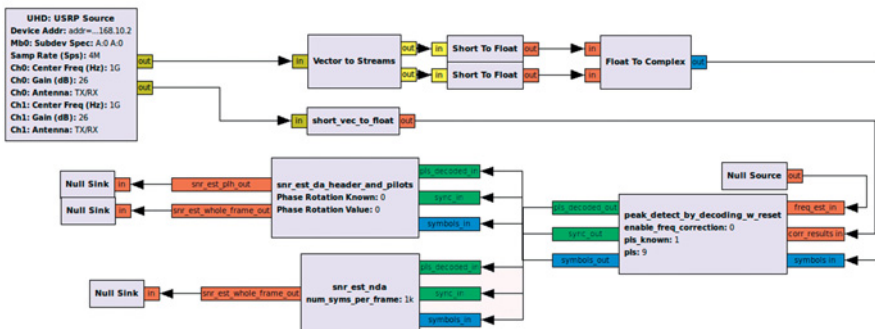

Screenshot of the GNU Radio blocks developed for analysing the signal-to-noise ratio (SNR) of a DVB-S2 signal.  
© JOANNEUM RESEARCH 2012

### Infobox

#### Project duration:

01 November 2011 – 30 April 2013

#### Coordinator:

JOANNEUM RESEARCH Forschungsgesellschaft mbH  
DIGITAL - Institute for Information and Communication  
Technologies (JR-DIG)

Michael Schmidt

Steyrergasse 17, 8010 Graz, Austria

T: +43 (0)316 876 – 1311

michael.schmidt@joanneum.at

[www.joanneum.at/digital/spa/taetigkeitsfelder/satelliten-und-terrestrische-breitbandkommunikation.html](http://www.joanneum.at/digital/spa/taetigkeitsfelder/satelliten-und-terrestrische-breitbandkommunikation.html)

It can therefore be seen that the development of the new Q/V band satellite emulator is very important in the exploration of this new band. A cost effective implementation on the flexible GNU Radio platform is planned.

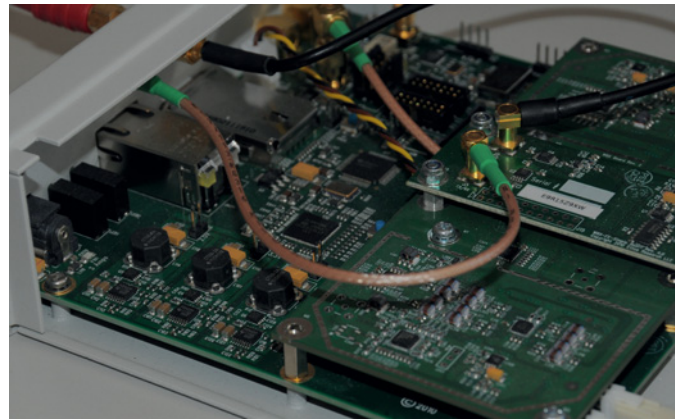

Hardware for the GNU Radio platform, which hosts down-converter, AD/DA converter, FPGA and interface to the PC via Ethernet. © JOANNEUM RESEARCH 2012

# CDPP

## Configurable Data Processing Platform

Many instruments on the payload of Earth observation and science satellites generate large amounts of data. As not all data can be downlinked to the ground via the available telemetry channels, they need to be processed on board the satellites. The data are formatted and compressed using powerful algorithms in order to reduce the amount of data prior to transmission.

The processing of these data requires fast Digital Signal Processing (DSP). The relevant equipment comprises ASICs (Application Specific Integrated Circuits), FPGAs (Field Programmable Gate Arrays), a programmable signal processor and, possibly, a micro-processor. New technology is needed to meet the steadily increasing requirements in terms of data processing speed. A number of space missions that require this next technological step are currently in the planning stage.

RUAG Space Austria (RSA) has been active in this technological area for many years, starting with DSP boards for various instruments of the MetOp satellite. This was followed by the design of signal on-board processing equipment for navigation signal generators and GPS receivers, such as the Sentinel GPS receiver.

The present activity was a logical step for RSA to maintain and further develop its know-how in digital signal processing and to continue provision of on-board electronics to the space market. The project comprised the identification of existing technologies such as signal processors, general purpose microprocessors as well as ASICs and FPGAs, and the design of possible DSP architectures, two of which were evaluated in the course of the project. One DSP architecture was selected for the design of a breadboard and the associated software. Furthermore, benchmarks were defined to verify the usability of the concept for selected applications.

Work on the design of the benchmark software as well as the basic software for the processor was supported by the Institute of Computer Engineering of the Vienna University of Technology.

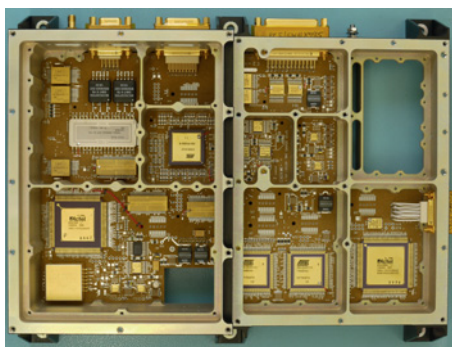

RUAG Space on-board signal processing board.  
© RUAG Space GmbH

### Infobox

#### Project duration:

01 January 2011 – 30 September 2013

#### Coordinator:

RUAG Space GmbH

Gerald Zeynard

Stachegasse 16, 1120 Vienna, Austria

T: +43 (0)1 80199 – 5729

gerald.zeynard@ruag.com

www.ruag.com/space

#### Partners:

Vienna University of Technology

Institute of Computer Engineering

Andreas Steininger

ti.tuwien.ac.at/ecs

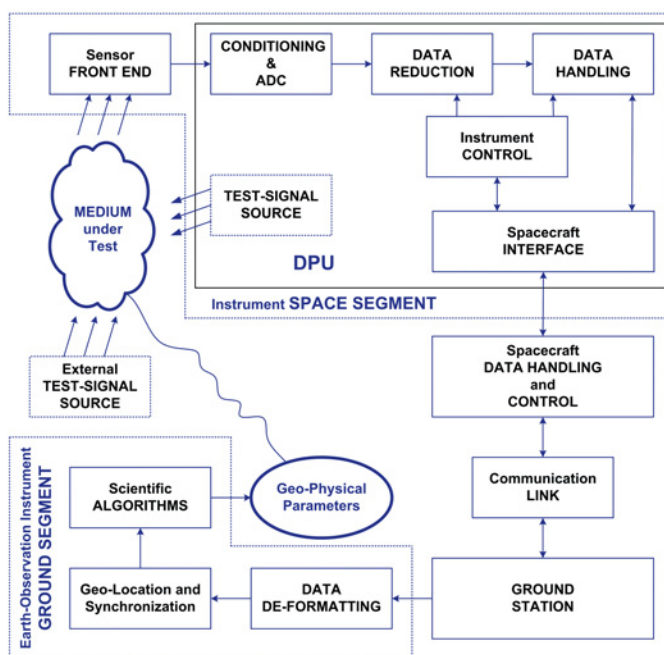

Data processing unit in the context of an Earth observation instrument.  
© RUAG Space GmbH

# COSA

## Core Solar Array Drive Electronics

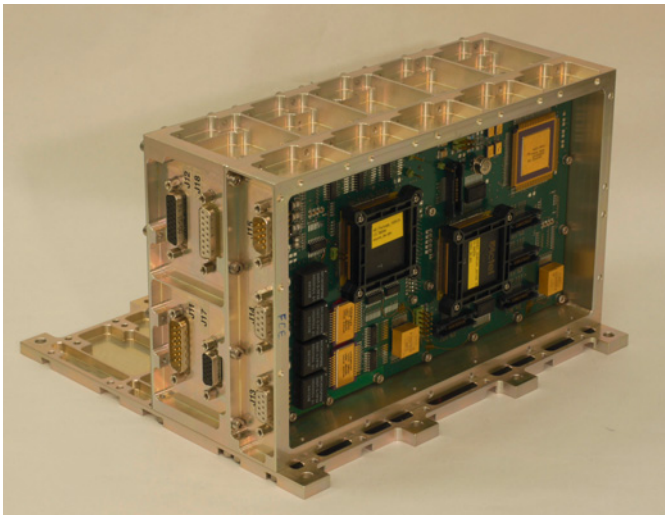

Example of high-end SADE (for Mercury mission). © RUAG Space GmbH

Satellites are usually powered by solar energy which is collected by solar panels. In most cases these solar panels are directed towards the Sun using solar array drive mechanisms (SADMs). The motors of these mechanisms are controlled by solar array drive electronics (SADEs).

One problem when supplying SADMs to different customers is that the power and control electronics interfaces between the motors and the satellite platforms vary a lot from satellite to satellite. In order to overcome this problem the COSA study set out to define a very simple and inexpensive "Core SADE" (see picture "Schematics of COSA"). This small electronics box converts output signals of the on-board computer to motor drive voltages in their simplest form. Usually this method is sufficient for telecom satellites. The Core SADE can be configured to cover different satellite bus voltages and different motor types. The COSA project involved the development of a new type of voltage control for the Core SADE which allows for economical operation/dimensioning of the electronics (or the motor), even in the case of extreme variations in motor temperatures (from  $-80^{\circ}$  up to  $+130^{\circ}$ ).

The study aimed to investigate the actual requirements of manufacturers of SADMs, motors and satellite primes and to build and test a breadboard incorporating an innovative voltage control concept.

### Infobox

#### Project Duration:

01 February 2012 – 31 July 2013

#### Coordinator:

RUAG Space GmbH

Gerhard Osterseher

Stachegasse 16, 1120 Vienna, Austria

T: +43 (0)1 80199 – 2290

gerhard.osterseher@ruag.com

www.ruag.com/space

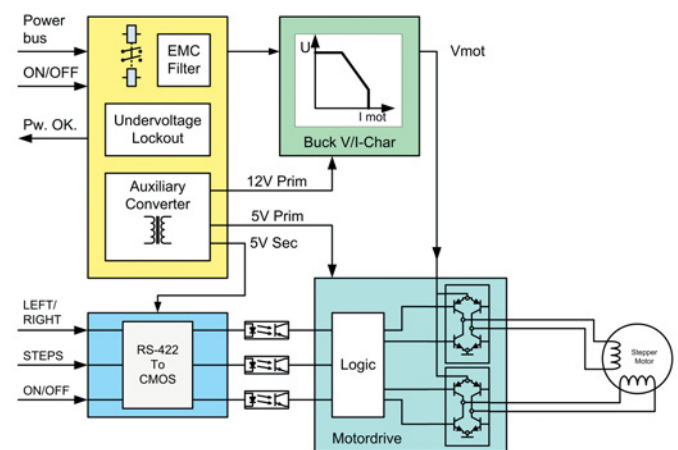
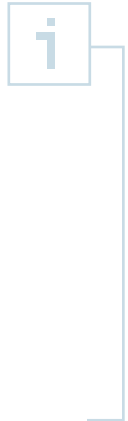

Schematics of COSA. © RUAG Space GmbH

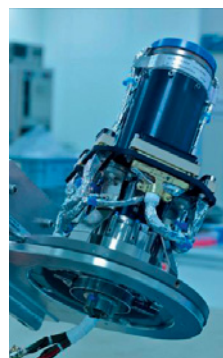

Typical solar array drive mechanism.  
© RUAG Schweiz AG

# GeMIE

## Generic Mission Independent EGSE Infrastructure

As a consequence of the extreme price pressure, both in the commercial and institutional market, satellite manufacturers consider the industrialization of Satellite Manufacturing, Assembly, Integration and Test (MAIT) as essential for a significant cost reduction while at the same time improving satellite quality.

Our solutions for mission specific RF-SCOE (Radio Frequency Special Check-Out Equipment) and Power SCOE systems, as well as our Payload EGSE (Electrical Ground Support Equipment) systems, are based on generic, mission independent products, constituting our Satellite Payload and Test System product family. Although there are still different products for each type of EGSE, there are a lot of commonalities (experience, design, software) among the different elements. Only mission specific new features are added to the proven generic product element for the development of a mission specific EGSE element.

This approach significantly reduces the risk and overall price for "traditional" mission specific EGSE/SCOE turnkey solutions and has thus helped us to increase our competitiveness. However, different mission targets and hence specific requirements in many cases require project-optimized solutions in hardware and software. For a generic, mission independent EGSE/SCOE infrastructure, the approach outlined above is mandatory and must be implemented in an even more rigorous manner.

The GeMIE study addressed the following major tasks:

- > Analyse and elaborate a concept for setting up a programme and mission independent EGSE/SCOE infrastructure.
- > Elaborate the design for a harmonized and standardized EGSE on the subsystem level.
- > Develop the requirements, concepts and design for generic, mission independent Power SCOE software, including validation by means of rapid prototyping.

### Infobox

#### Project duration:

01 October 2010 – 31 December 2012

#### Coordinators:

Siemens AG Österreich

CMT (Communications, Media & Technology)

Hannes Kubr

Siemensstraße 90, 1210 Vienna, Austria

T: +43 (0)5 1707 – 42696

hannes.kubr@siemens.com

www.siemens.at/space

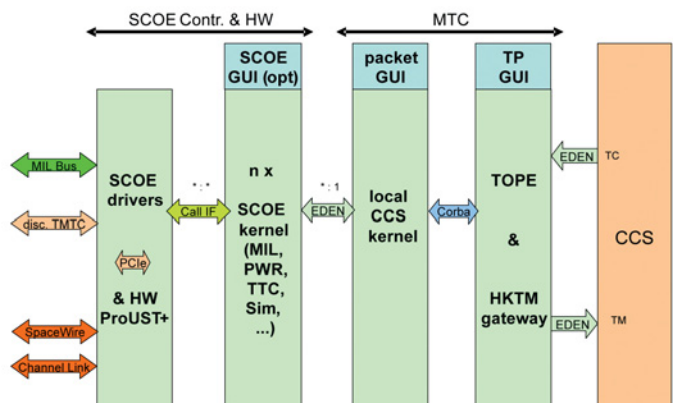

First overall architecture for the EGSE infrastructure.

© Siemens AG Österreich

# NextNav

## Next On-Board Navigation Receiver Advancement

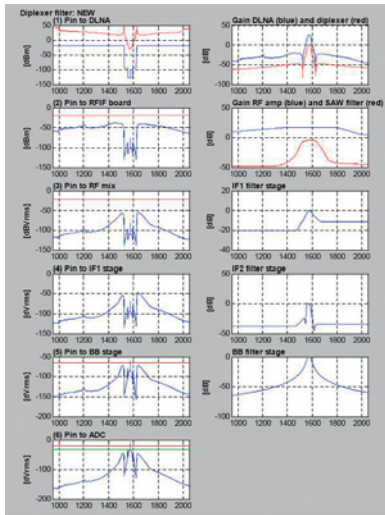

Example of RUAG's RFC analysis tool showing the L1 band.  
© RUAG Space GmbH

GPS (Global Positioning System) receivers represent a core product line of RUAG Space GmbH, based on expertise that has been built up over many years. RUAG has very successfully developed the GPS Precise Orbit Determination (POD) receiver resulting in orders for 20 flight models.

The NextNav project initiated the development of next generation receivers, which focuses not only on POD receivers, but also addresses other GNSS (Global Navigation Satellite System) receiver market needs, like platform navigation receivers including geostationary orbits (GEO) and GNSS receivers for launcher applications.

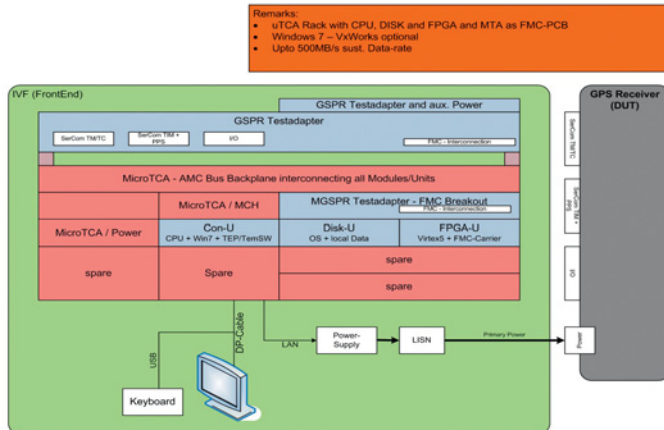

Modernized test equipment concept. © RUAG Space GmbH

### Infobox

#### Project duration:

01 November 2010 – 31 May 2013

#### Coordinator:

RUAG Space GmbH

Alfred Werni

Stachegasse 16, 1120 Vienna, Austria

T: +43 (0)1 80199 – 5509

alfred.werni@ruag.com

www.ruag.com/space

The NextNav project prepared the next generation of receivers by performing mission analyses, establishing requirements, defining the verification environment and characterizing the RUAG Space GPS POD receivers for various types of applications. In addition, design trade-offs and architectural design concepts were elaborated.

A signal processing prototyping environment was established to evaluate and validate new channel processing hardware required for generating the spread-spectrum signals (code/carrier generation) and for performing signal correlation, together with the necessary software.

Additionally, the project improved the current generation of POD receivers by performing basic studies in the area of verification and radio frequency compatibility. The NextNav project thus helped to secure our market success for the future while opening up the potential for entering new, promising segments.

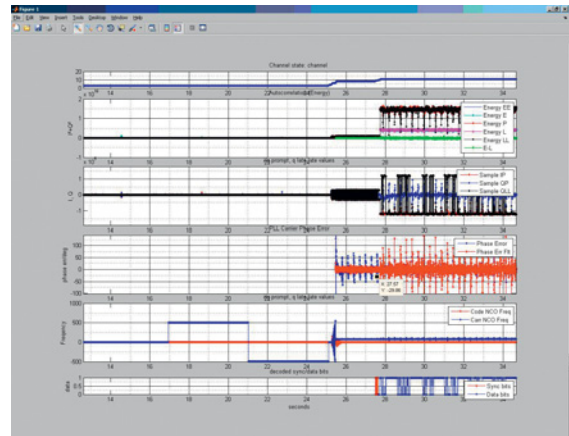

Graphical overview of example diagnostics data (GAL E5A). © RUAG Space GmbH

# ONE-SAT-ILS

## One Satellite Geolocation System

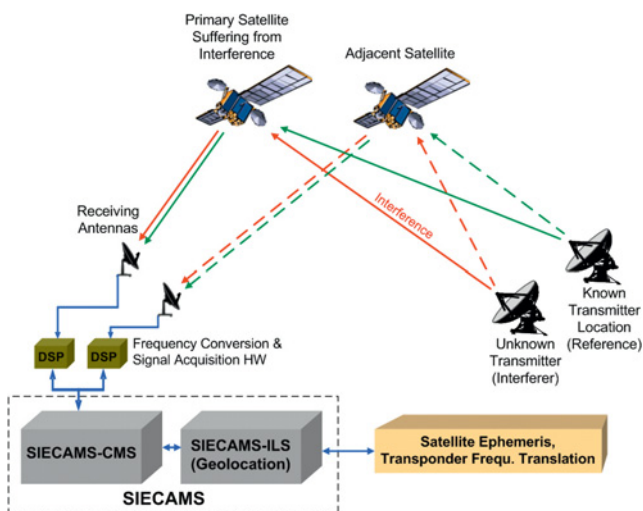

SIECAMS ILS architecture. © Siemens 2012

The growing demand for satellite communication links, mainly forced by governmental programmes in order to provide Internet access and telephony even in poorly developed areas, and the availability of new technologies enabling cheap VSAT solutions for everyone (e.g. ASTRA2Connect from SES or Tooway from Eutelsat) lead to an increasing volume of satellite signals, but also to increasing interferences (as a result of bad installations or poorly pointed antennas).

Acts of terrorism or civil commotion (e.g. systematic jamming of western broadcast television in the North African and Middle East region, like Egypt, Syria, Libya, Iran, etc.) are another reason for increasing interferences.

Satellite operators are thus increasingly interested in solutions for not only detecting interferences, which is the main task of a satellite monitoring system, but also for localizing them. This involves geographically localizing, or geolocating, the transmit station of an interferer.

However, such localization systems have a crucial drawback: they need to receive the interference signal via two adjacent satellites for geolocation (see picture above).

Siemens has developed a geolocation system, called SIECAMS ILS, which is already on the market. Based on requests from customers an internal discussion was started about the possibility to do geolocation with just one satellite with acceptable accuracy. In a "brainstorming project" various solutions were discussed and described in a concept paper.

### Infobox

#### Project duration:

01 October 2011 – 30 June 2012

#### Coordinator:

Siemens AG Österreich  
CMT (Communications, Media & Technology)  
Erwin Greilinger  
Siemensstraße 90, 1210 Vienna, Austria  
T: +43 (0)51707 – 42632  
erwin.greilinger@siemens.com  
www.siemens.at

#### Partners:

AIT Austrian Institute of Technology GmbH  
Michael Nölle  
www.ait.ac.at

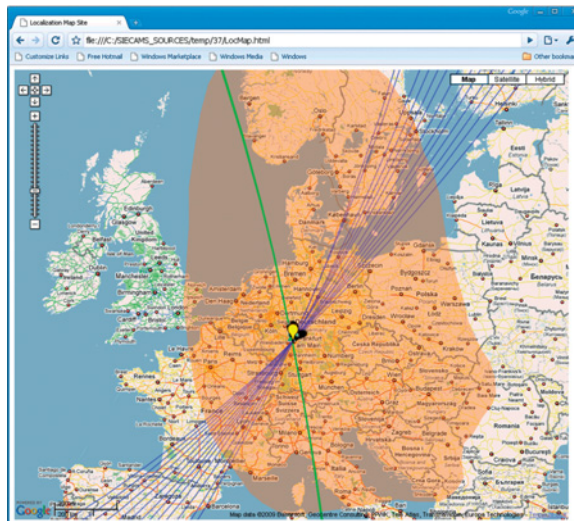

SIECAMS ILS continuous measurement. © Siemens 2012

The ONE-SAT-ILS project aimed to select one or two of the discussed solutions with the potential for implementation in a product. Potential was defined to mean technical feasibility in terms of effort (time and money) but also in terms of accuracy and performance. Furthermore, the chosen solutions were implemented in a prototype in order to evaluate the potential described above. The results obtained from ONE-SAT-ILS will be integrated in the Siemens ILS system in a subsequent project (see picture above).



# QTS

## Quantum Teleportation in Space

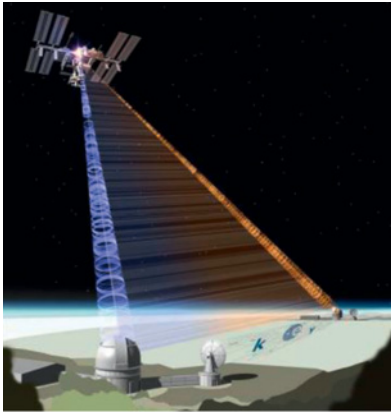

The Space-QUEST mission will involve placing a source of entangled photons on a LEO platform such as the International Space Station (ISS).  
© IQOQI Vienna

The Space-QUEST (Quantum Entanglement for Space Experiments) mission will involve quantum experiments in space in the future. Objectives for the Space-QUEST experiments include demonstrating fundamental quantum physics principles beyond the distance capabilities on Earth as well as absolutely secure quantum key distribution from space to ground.

The aim of the QTS (Quantum Teleportation in Space) project was to bridge the gap between the laboratory setting of quantum teleportation and its future implementation in space. Specifically, we planned to perform a proof-of-principle experiment for free-space quantum teleportation over long distances. Since the long term objective was to perform the teleportation of a given unknown quantum state from a ground station to a satellite we investigated the performance of teleportation over a 144 km long free space transmission path between the Canary Islands of La Palma and Tenerife in an intermediate step.

First, the requirements for the teleportation system to be utilized in harsh real-world conditions were investigated theoretically. Based on the results, a suitable setup was designed and developed in the shielded laboratory, where the performance of the whole system was tested in detail at the component level. After the successful performance verification phase, the complete teleportation system was disassembled, shipped to the Canary Islands and again set up for performing the proof-of-principle field experiment in a realistic setting over a 144 km free-space path.



A schematic of the 144 km long optical free-space path between the Canary Islands of La Palma and Tenerife. © IQOQI Vienna

### Infobox

#### Project duration:

04 January 2011 – 31 December 2012

#### Coordinator:

Austrian Academy of Sciences, Institute for Quantum Optics and Quantum Information (IQOQI)

Rupert Ursin

Boltzmannngasse 3, 1090 Vienna, Austria

T: +43 (0)1 4277 – 29565

rupert.ursin@univie.ac.at

www.quantum.at

Finally, we were able to teleport a series of four different input states from La Palma to Tenerife. The obtained results showed a teleportation quality which was well above the limit that could be achieved by classical means. Our work explored the limits for ground-based free-space quantum teleportation, and our setup was able to cope with the optical link attenuation expected for a quantum transmission from a ground-based transmitter to a Low Earth Orbiting (LEO) satellite receiver. This experiment represented a crucial step towards future quantum networks in space. The technology involved has reached maturity and is set to play a key role in a new era of fascinating experiments.

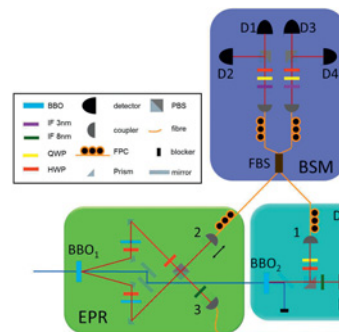

The figure schematically shows the optical setup of the quantum teleportation experiment deployed in La Palma.  
© IQOQI Vienna

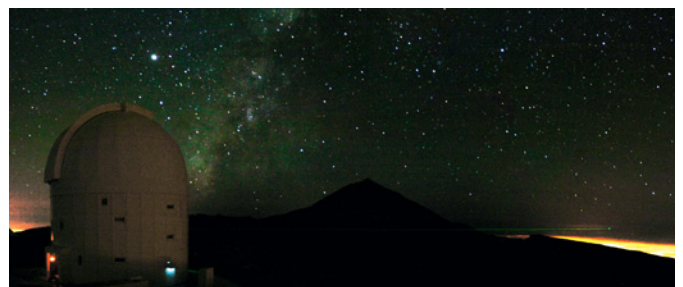

The receiving telescope (OGS owned by ESA) in Tenerife. The green laser was used for correct pointing of the telescopes. © Thomas Herbst



### Infobox

**Project duration:**

01 August 2011 – 31 March 2013

**Coordinator:**

RUAG Space GmbH

Alfred Werni

Stachegasse 16, 1120 Vienna, Austria

T: +43 (0)1 80199 – 5509

alfred.werni@ruag.com

www.ruag.com/space

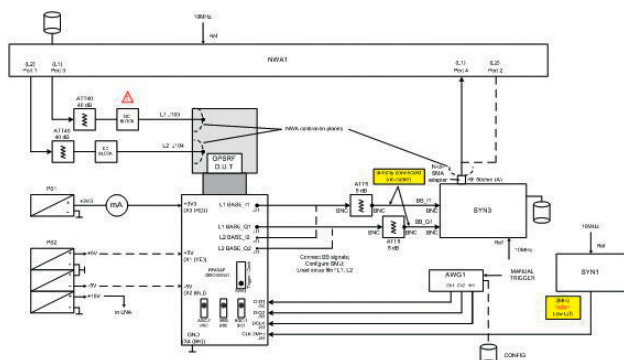

Block diagram of RFDC/G1 test setup. © RUAG Space GmbH

Over the past years, RUAG Space has established a strong position in the European market for space qualified high-performance GPS (Global Positioning System) receivers suitable for Precise Orbit Determination (POD).

Analysis of future mission scenarios established by potential customers and planned European missions like MetOp Second Generation led to the conclusion that strong on-board (e.g. X-band radar instruments, search and rescue transmitter) and also terrestrial interferers like air traffic radar in various RF (Radio Frequency) bands may lead to degradation of POD performance in the future.

The SGIS project started with the analysis of future on-board and terrestrial interference scenarios, the analysis and identification of interference suppression techniques suitable for implementation with space technology, and the isolation of candidate solutions.

The next phase involved the design of interference suppression hardware to be used as replacement for GNSS radio frequency down converter (RFDC) modules being part of our current on-board GNSS receiver products.

These next generation down converter modules meet the demand for more flexibility and smaller foot prints and take into account GNSS RF carrier and bandwidth flexibility and design for testability and manufacturability.

This phase also included manufacturing and board level testing. The final phase will consist of testing and post processing of test data to validate the concepts implemented within the project.



RFDC/G1 test setup. © RUAG Space GmbH

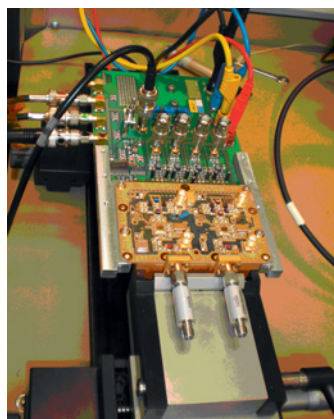

RFDC/G1 installed on test adaptor RF\_ADAP.  
© RUAG Space GmbH

# TCTM

## Model Driven TC/TM Protocol Design

Communication with satellites is based on a so-called telecommand (TC)/telemetry (TM) interface. This interface is also maintained on the satellite platform to interconnect its instruments with the central on-board computer.

Although this kind of interface is standardized, the definition leaves certain freedom for mission-specific implementations. In the design of satellite instruments the NRE (non-recurring engineering) effort required to adapt the TC/TM interface to the actual needs of the mission is significant as modifications affect not only the flight software but also the documentation, the Satellite Reference Database (SRDB) and the test software. The TCTM project aimed to establish a single definition source for the TC/TM interface and to automatically generate the respective documentation, SRDB, flight software and test equipment software to reduce the NRE effort for future instrument developments.

The following design tasks were performed within the framework of the project:

- > The database itself was defined on an XML basis including all generic definitions for TC/TM protocols.
- > The API (Application Programming Interface) was established supporting functions to extract, add, delete and modify database items. This API was written in C++ and provides extensive consistency checks on the database.
- > A GUI (Graphical User Interface) was developed to define TCTM entries (TCTM DefEditor). This editor is also based on the API and uses the Qt library for the graphical functions.

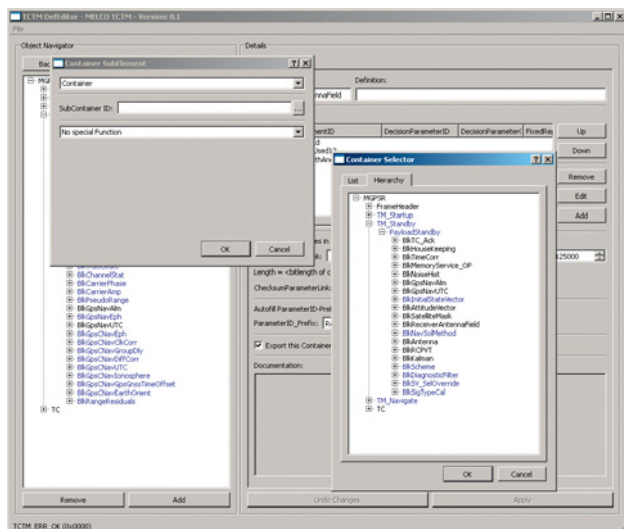

Screenshot of TCTM DefEditor. © RUAG Space GmbH

## Infobox

### Project duration:

01 September 2011 – 30 November 2012

### Coordinator:

RUAG Space GmbH

Heinrich Fagner

Stachegasse 16, 1120 Vienna, Austria

T: +43 (0)1 80199 – 5526

heinrich.fagner@ruag.com

www.ruag.com/space

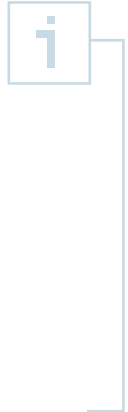

The work performed was subjected to practical testing within the framework of a new TC/TM interface for an upcoming satellite mission. The complete TC/TM structure for the mission was established via the TCTM DefEditor and subsequently used by the TEM SW (Test Equipment Manager Software).

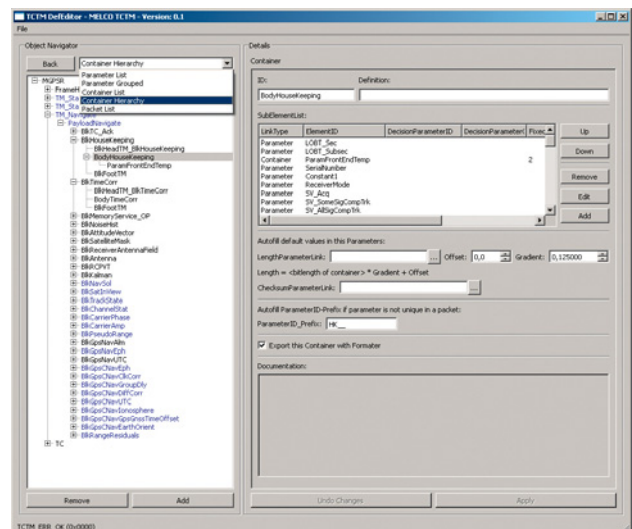

Screenshot of TCTM DefEditor showing the container selector. © RUAG Space GmbH

# TM/TC Modem

## Telemetry and Telecommand Modem and Interface Processing Equipment for EGSE and Ground Stations

Siemens AG Österreich has a long-standing (more than two decades) and highly successful record of developing and delivering Radio Frequency Special Check-Out Equipment (RF-SCOE) and Telemetry, Telecommand and Control Special Check-Out Equipment (TT&C SCOE) for satellite and payload testing. This ASAP 8 project is designed to enhance the flexibility and functionality of our TT&C SCOE and Payload EGSE (Electrical Ground Support Equipment) solutions, but also to extend our business to the ground station area by elaborating the detailed requirements, system and detail design for a modem, both for EGSE and ground station systems. The concepts and design will be validated by practical investigations and evaluations.

Based on the success of our new FPGA (Field Programmable Gate Array) based product line ProUST/ProUST+ we are confident that the consortium will be able to develop the baseline for an innovative and highly integrated TM/TC modem with leading-edge price/performance ratio.

Future Siemens TT&C SCOE, RF-Suitcase and EGSE systems will be based on our own highly integrated innovative products to provide our customers with outstanding performance.

### Infobox

#### Project duration:

23 May 2012 – 24 April 2013

#### Coordinator:

Siemens AG Österreich  
 CMT (Communications, Media & Technology)  
 Werner Keim  
 Siemensstraße 90, 1211 Vienna, Austria  
 T: +43 (0)51707 – 42635  
 keim.werner@siemens.com  
 www.siemens.at/space

#### Partner:

JOANNEUM RESEARCH Forschungsgesellschaft mbH  
 DIGITAL - Institute for Information and Communication Technologies (JR-DIG)  
 Michael Schmidt  
 www.joanneum.at/digital

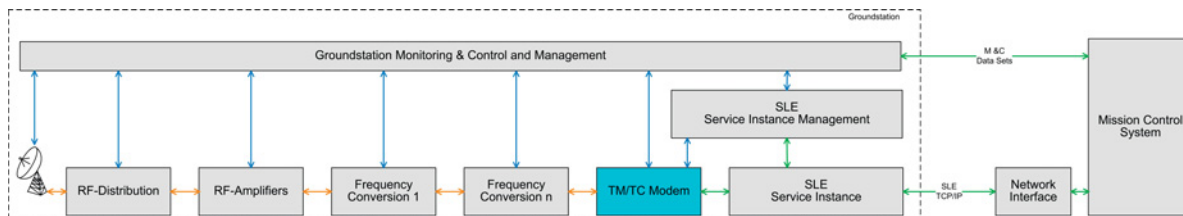

Ground station functional overview. © Siemens AG Österreich

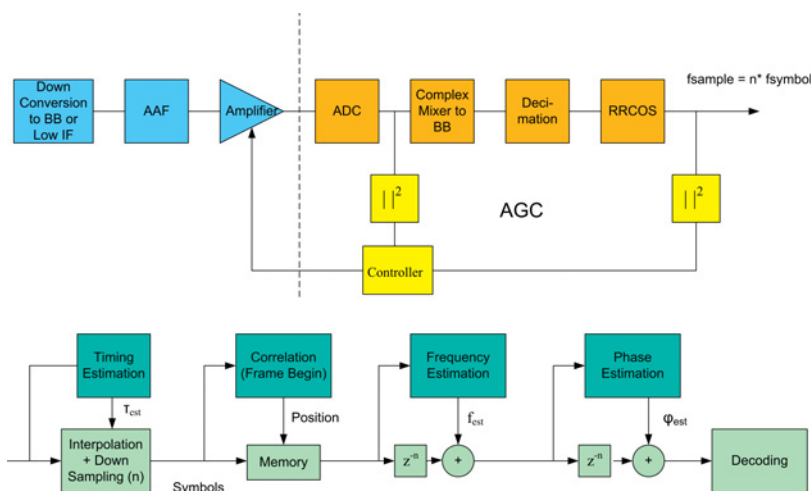

Modem abstract architecture. © JOANNEUM RESEARCH

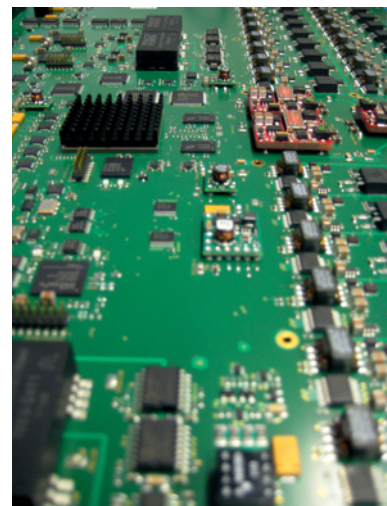

ProUST/ProUST+ product line. © Siemens AG Österreich

# Contacts

## Programme Responsibility

bmvit – Federal Ministry for Transport,  
Innovation and Technology  
Andrea Kleinsasser  
Renngasse 5, 1010 Vienna, Austria  
T: +43 (0)1 71162 – 652904  
andrea.kleinsasser@bmvit.gv.at  
www.bmvit.gv.at



## Programme Management

Austrian Research Promotion Agency  
Aeronautics and Space Agency  
Harald Posch  
Sensengasse 1, 1090 Vienna, Austria  
T: +43 (0)5 7755 3001  
harald.posch@ffg.at  
www.ffg.at



**More information and relevant documents:  
[www.ffg.at](http://www.ffg.at)**

## Published by

Federal Ministry for Transport, Innovation and Technology  
Renngasse 5, 1010 Vienna, Austria    [www.bmvit.gv.at](http://www.bmvit.gv.at)

Design & Production:  
Projektfabrik Waldhör KG, [www.projektfabrik.at](http://www.projektfabrik.at)  
Photos: Project partners of bmvit, ESA, Projektfabrik

Photo: Nanosatellite BRITE-Austria, Picture Credit: Österreichische Post AG

